

# BLÜCHER® Marine Product Catalogue

BLÜCHER® Marine Stainless Steel Sanitary Discharge System



**BLÜCHER®**

A **WATTS** Brand

# NEW PRODUCTS IN THIS CATALOGUE



**NEW**  
FAST AND EASY  
INSTALLATION

**BLÜCHER®  
PLUG & PLAY  
PENETRATION**  
TYPE 868.910.xxx



**NEW**  
Ø50 MM

**BLÜCHER®  
Access Pipe**  
TYPE 840.xxx.xxx



**BLÜCHER® SYSTEM-X TRANSITION ADAPTOR  
WITH BLÜCHER® SOCKET / SYSTEM X SPIGOT**  
TYPE 859.xxx.xxx

**SYSTEM-X TRANSITION ADAPTOR  
WITH BLÜCHER® SPIGOT / SYSTEM X SOCKET**  
TYPE 859.xxx.xxx



**NEW**  
BLÜCHER®  
SYSTEM-X



**BLÜCHER®  
PENETRATION  
WITH SLEEVE  
FOR WELDING**  
TYPE 866.015.xxx

**NEW**  
SHORT STANDARD  
PENETRATIONS

**BLÜCHER®  
FLANGED  
PENETRATION  
WITH SLEEVE  
FOR WELDING**  
TYPE 868.000.xxx

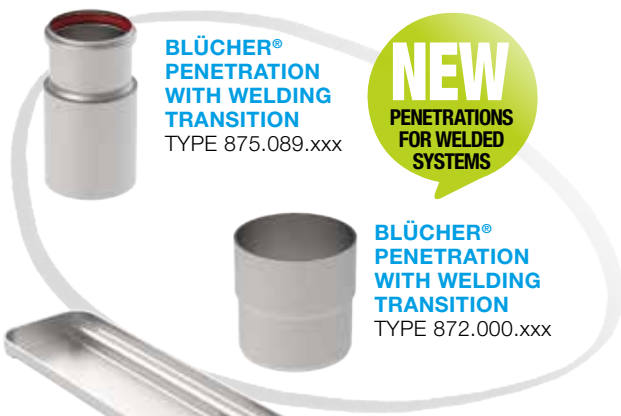

**BLÜCHER®  
PENETRATION  
WITH WELDING  
TRANSITION**  
TYPE 875.089.xxx

**NEW**  
PENETRATIONS  
FOR WELDED  
SYSTEMS

**BLÜCHER®  
PENETRATION  
WITH WELDING  
TRANSITION**  
TYPE 872.000.xxx



**NEW**  
BENDS

**OLD WITH  
WELDING**

**NEW  
WITHOUT  
WELDING**



**NEW**

**BLÜCHER®  
CHANNELS**  
• OceanLine  
• FlatLine  
• MarineLine  
• MultiLine  
• WaterLine

**BLÜCHER®  
LOWER PARTS  
FOR THICKWALLED  
OUTLET**  
TYPE 470.000.xxx  
TYPE 475.000.xxx



**NEW**  
FRAME DESIGN

**BLÜCHER® UPPER PARTS  
FOR MARINE DRAIN**  
TYPE 472.310.110



# TABLE OF CONTENTS

<b>1. PRESENTATION OF BLÜCHER</b>		
New products in this catalogue	2	
About us	4	
Introduction to the Marine Product Catalogue	4	
Take us on board	5	
The Marine Engineering Handbook	5	
Team Marine	6	
Representatives	6	
Approved drainage solutions for marine	7	
Where to use BLÜCHER	8	
Approvals and Certificates	10	
<b>2. BLÜCHER® EUROPIPE</b>		
Presentation of BLÜCHER® EuroPipe - pipes and fittings	11	
Pipes	12	
Fittings - Bends	14	
Fittings - Branches	16	
Fittings - Access pipes and bends	18	
Fittings - Sockets	19	
Fittings - Increasesers and reducers	20	
Fittings - Adaptors	21	
Fittings - Toilet adaptors	23	
Fittings - Others	24	
Accessories	25	
Penetrations for steel decks and bulkheads	30	
Penetrations for aluminium decks and bulkheads	34	
Technical data	35	
JOINTING of BLÜCHER® EuroPipe - step by step	36	
Suspension of BLÜCHER® drainage pipes	38	
Cutting of BLÜCHER® EuroPipe	39	
BLÜCHER® cutting tools	39	
Stainless steel – Marine applications	40	
How to determine material quality by label colour	40	
Pressure performance	41	
<b>3. BLÜCHER® DRAIN MARINE</b>		
Presentation of marine drains	42	
Marine drains overview	43	
Marine lower parts for steel decks	44	
Marine drains for tiled floors and steel decks	47	
Marine lower parts for aluminium decks	50	
Marine upper parts for tiled and wooden floors	52	
Marine upper parts for resin floors	53	
Marine upper parts for vinyl floors	54	
Accessories for marine drains	55	
<b>4. GROUP PENETRATION</b>		
Jointing unit with group penetration	60	
Jointing unit for steel decks	61	
<b>5. BLÜCHER® CHANNEL</b>		
Presentation of channels and kitchen channels	62	
Marine channel overview	64	
BLÜCHER® FlatLine	66	
BLÜCHER® OceanLine	72	
BLÜCHER® WaterLine	78	
BLÜCHER® MarineLine	86	
BLÜCHER® MultiLine	94	
Accessories	98	
<b>6. BLÜCHER® GREASE SEPARATOR</b>		
Presentation of grease separators	102	
<b>7. WHERE TO FIND INSTALLATION VIDEOS</b>		
Information about installation and maintenance	104	



# ABOUT US

## Danish Design and Production

Founded in Denmark in 1965, BLÜCHER has developed into a leading manufacturer of stainless steel drainage systems. Today, BLÜCHER is an international company with subsidiaries and representations worldwide. The BLÜCHER Group employs more than 400 staff worldwide.

Customers all over the world appreciate our know-how, dedicated service, and common sense.

Through quality stainless steel products and drainage solutions that lead waste water away, BLÜCHER is committed to the promise of keeping up the flow.

The BLÜCHER® drainage products are manufactured in Denmark using the most modern production methods and in accordance with the internationally recognised quality standards ISO 9001 and ISO 14001. Furthermore, the most respected classification societies endorse the BLÜCHER® drainage products worldwide.

## Safe Solutions for Marine

Since the early 1980's, BLÜCHER's sanitary discharge system for marine applications has been the first choice sanitary discharge system for newbuilding and refitting of ships in Denmark, quickly followed by leading shipyards world-wide.

To date BLÜCHER® sanitary discharge system has been installed in more than 3000 vessels worldwide ranging from cruise liners, luxury yachts and ferries to merchant ships, naval vessels and off-shore facilities.

**BLÜCHER is the preferred supplier to several of the largest shipyards worldwide, among them Meyer Group, Fincantieri, Chantiers de l'Atlantique, MV Werften, Daewoo.**



## Introduction to the **Marine Product Catalogue**

Welcome to the new **BLÜCHER® Marine Product Catalogue**. This catalogue contains BLÜCHER's products for the Marine segment – suitable for all kind of vessels and offshore constructions.

### Disclaimer

BLÜCHER reserves the right to change or modify product design, construction, specifications, or materials without prior notice and without incurring any obligations to make such changes and modifications on BLÜCHER® products previously or subsequently sold. BLÜCHER cannot be held responsible for any malfunction of the system due to incorrect design or installation.

### Support

For more information about the BLÜCHER® sanitary discharge system and the individual BLÜCHER® product groups please see BLÜCHER's brochures, installation instructions and websites. BLÜCHER has a global network of agents and distributors who can offer guidance and advice in relation to your drainage project. Go to [www.blucher-marine.com](http://www.blucher-marine.com) to find your local representative.







## TAKE US ON BOARD

We are the first-choice sanitary discharge system for newbuilding and refitting of all types of vessels. Our long-lasting sanitary discharge system has been installed in more than 3,000 vessels worldwide ranging from cruise liners and luxury yachts to naval vessels and offshore facilities.



**CRUISE SHIPS  
AND FERRIES**



**LUXURY  
YACHTS**



**COMMERCIAL  
VESSELS**



**OFFSHORE &  
NAVAL VESSELS**



**TRAWLERS**



**ICEBREAKERS**



MARINE

### Marine

The BLÜCHER® EuroPipe drainage pipework system is completely interchangeable between vacuum and gravity systems for black- and grey-water in marine applications. **Shipyards** and **owners** all over the world depend on longevity, low weight and the fire-resistant, hygienic and reliable solution for their sanitary discharge system.



COMMERCIAL

### Commercial

The light-weight push-fit system combined with the exceptional fire resistant solution make BLÜCHER® EuroPipe the preferred pipe system in projects around the world. **Hospitals, schools, airports** and other **commercial customers** are among our loyal clients.



HOUSING

### Housing

Within the housing area BLÜCHER® EuroPipe is suitable for new building and renovation projects. BLÜCHER® EuroPipe provides the right flow in **single-family houses** and from the top floor to the basement in multi-storey housing.



INDUSTRIAL

### Industrial

**The food, beverage** and **pharmaceutical industries** value in particular the hygienic and sustainable BLÜCHER® EuroPipe solution. The smooth stainless steel surface and high flow capacity prevent deposits inside the pipework system, and the stainless steel provides a solution, which requires a minimum of maintenance and offers maximum longevity. In AISI 316L steel the pipe system also provides a durable solution for the chemical industry.

## See also the **Marine Engineering Handbook**

The new **Marine Engineering® Handbook** offers a wealth of information on the BLÜCHER sanitary discharge system as well as a technical overview of the individual BLÜCHER® product groups for marine applications.

The Marine Engineering Handbook also contains guidelines for installation, testing and maintenance of a BLÜCHER® sanitary discharge system.

For more details on the Marine Engineering Handbook, please reach out to BLÜCHER.



# PRESENTATION OF BLÜCHER

## MARINE TEAM



Michael Tønnesen  
**Head of Global Marine Sales and Customer Center**  
[mtn@blucher.com](mailto:mtn@blucher.com)  
 T +45 99 92 08 24  
 M +45 61 55 63 99



Allan Falkesgaard  
 Commercial Project Manager, Marine  
[afa@blucher.com](mailto:afa@blucher.com)  
 T +45 99 92 09 32  
 M +45 51 81 55 74  
 MARKETS:  
 · Denmark  
 · Germany  
 · Netherlands



Jan Ooppelstrup  
 Fire Safety & Technical Sales Manager, Marine  
[jo@blucher.dk](mailto:jo@blucher.dk)  
 T +45 99 92 08 42  
 M +45 51 96 94 64  
 MARKETS:  
 · Turkey  
 · Romaina  
 · Russia



Elwayne Tan  
 Area Sales Manager, Marine  
[elt@blucher.com](mailto:elt@blucher.com)  
 M +65 9787 4924  
 MARKETS:  
 · Asia Pacific  
 · Middle East



Lena Henningsen  
 Area Sales Manager, Marine  
[leh@blucher.com](mailto:leh@blucher.com)  
 T +45 99 92 08 26  
 M +45 28 93 39 08  
 MARKETS:  
 · Poland  
 · Croatia  
 · Spain  
 · Portugal  
 · Baltics  
 · Greece



Luca Russo  
 Area Sales Manager, Italy, Marine  
[lur@blucher.com](mailto:lur@blucher.com)  
 M +39 3357544515  
 MARKETS:  
 · France  
 · Italy  
 · Americas  
 · Africa



Elling Strand  
 Sales Consultant  
[els@blucher.no](mailto:els@blucher.no)  
 T +47 35 94 26 53  
 M +47 90 54 37 44  
 MARKET:  
 · Norway



Fraser Little  
 Regional Sales Manager  
[flr@blucher.co.uk](mailto:flr@blucher.co.uk)  
 M +44 7850 796 673  
 MARKET:  
 · UK

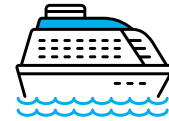

MARINE

### SELECTED REFERENCES

Vessels, hospitals, schools, commercial kitchens, the food and beverage industry and the pharmaceutical industry are among the customers that benefit from BLÜCHER® stainless steel drainage systems.

#### Marine

More than 3000 vessels in more than 30 countries since 1982.

For a complete list of references, please visit [www.blucher-marine.com](http://www.blucher-marine.com)

## REPRESENTATIVES

BLÜCHER is represented by local specialists within marine applications around the World. If a local specialist for your area is not listed below, please contact our HQ Marine Sales.

### Country

Argentina  
 Australia  
 Brazil  
 Chile  
 China  
 Croatia  
 Finland  
 Germany  
 Greece  
 India  
 Italy  
 Japan

### Representative

Ferreya & Asociados S.H.  
 Galvin Marine Industrial  
 Rui Neiva Representacoes Ltda  
 Chile Maquinarias & Inv. Tecnicas S.A.  
 TECWAY International (Marine) Ltd  
 CROCON d.o.o  
 Polarputki OY  
 EVAC Germany GmbH  
 EPE S.A.  
 VACman Sanitation Solutions Pvt. Ltd.  
 Stelio Bardi SRL  
 Harada Corporation

Netherlands  
 Poland  
 Romania  
 Russia  
 Singapore  
 South Korea  
 Spain/Portugal  
 Taiwan  
 Turkey  
 UAE  
 USA  
 Vietnam

Nicoverken Marine Services B.V.  
 Altro Marine Sp.z.o.o.  
 Danube Rainbow Ltd  
 JAMA-Engineering  
 Technique Marine Services Pte Ltd  
 Jeitek Corporation  
 Disolter, S.L.  
 Union Group  
 DOP Ltd  
 Technology Ventures Middle East FZC  
 EMS European Metric Steel  
 MTS International JSC



## APPROVED DRAINAGE SOLUTIONS FOR MARINE - ONE COMPLETE SYSTEM



### BLÜCHER® EuroPipe

is a complete stainless steel sanitary pipework system approved for installation in ships. It is the natural choice of the shipbuilding industry when looking for safe, lightweight, easy-to-install and low-maintenance solutions.

The push-fit joint is completely interchangeable between either gravity or vacuum discharge systems. In addition to sanitary discharge it is also suitable for central vacuum cleaning systems, garbage disposal systems, etc. The benefits of being able to use the same pipework system throughout the vessel, regardless of the type of system employed, can offer significant installation savings.

The advantages at a glance:

- All in stainless steel
- Available in OD 40, 50, 75, 110, 125, 160 and 200 mm in standard lengths from 0,15 to 6 metres
- Fast and simple installation due to push-fit socket and spigot end jointing
- Easily combined with other pipe materials
- Low weight of material and only 1-1,50 mm wall thickness
- Completely interchangeable between vacuum and gravity installations
- Designed in accordance with EN1124



### BLÜCHER® Drain Marine

have been developed in conjunction with leading shipyards worldwide. As a result, the product offering meets the specific demands of each individual installation regardless of the deck construction. BLÜCHER® Marine drains are suitable for welding in the deck and some for non-welded installation, can be fitted with a removable water trap (providing full rodding access from above) and are available to suit any deck finish. The advantages at a glance:

- All in stainless steel
- Modular system providing numerous possible combinations
- Multi-adjustable
- A solution for any deck finish
- Removable water trap providing efficient water seal and easy rodding access from above
- Protective cover on all lower parts



### BLÜCHER® Channel

stainless steel drainage channels are modular deck drainage solutions for use in galleys, pantries, door openings, outside deck areas, etc. Drainage channels are available to suit all deck finishes with a range of gratings developed to suit the varying load-bearing and flow demands. Outlets are available with a removable water trap and where applicable a filter basket to prevent solids discharging into the drainage system. Customised components are available on request.

- All in stainless steel
- Modular system providing numerous possible combinations
- Multi-adjustable
- Excellent flow and self-cleansing properties
- Perfect hygiene
- Wide range of gratings



# Where to use BLÜCHER

## BLÜCHER® EuroPipe

Selected applications:

- Black water – vacuum & gravity
- Grey water
- Deck drain piping
  - Outside / balcony piping
  - Central vacuum cleaning system (CVC)
  - Food waste system
  - Ventilation pipes
  - Drainage piping for engine rooms

## BLÜCHER® Drain Marine

Selected applications:

- Balconies
- Cabin areas
- Galley areas
- Shower drains
- Public areas

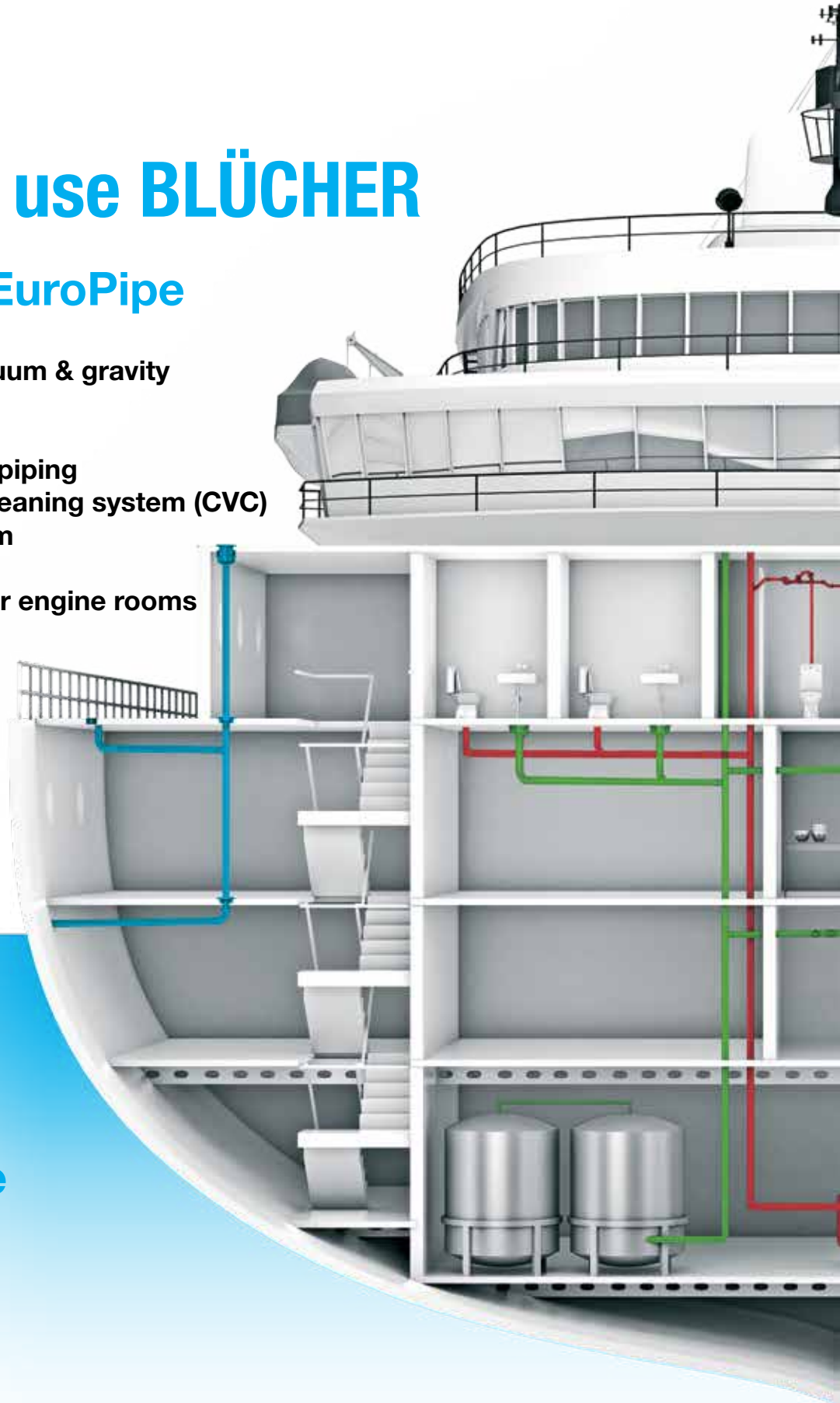



## BLÜCHER® Channel

Selected applications:

- Galley areas / pantries
- Corridors
- Laundry rooms

## BLÜCHER® Grease Separator

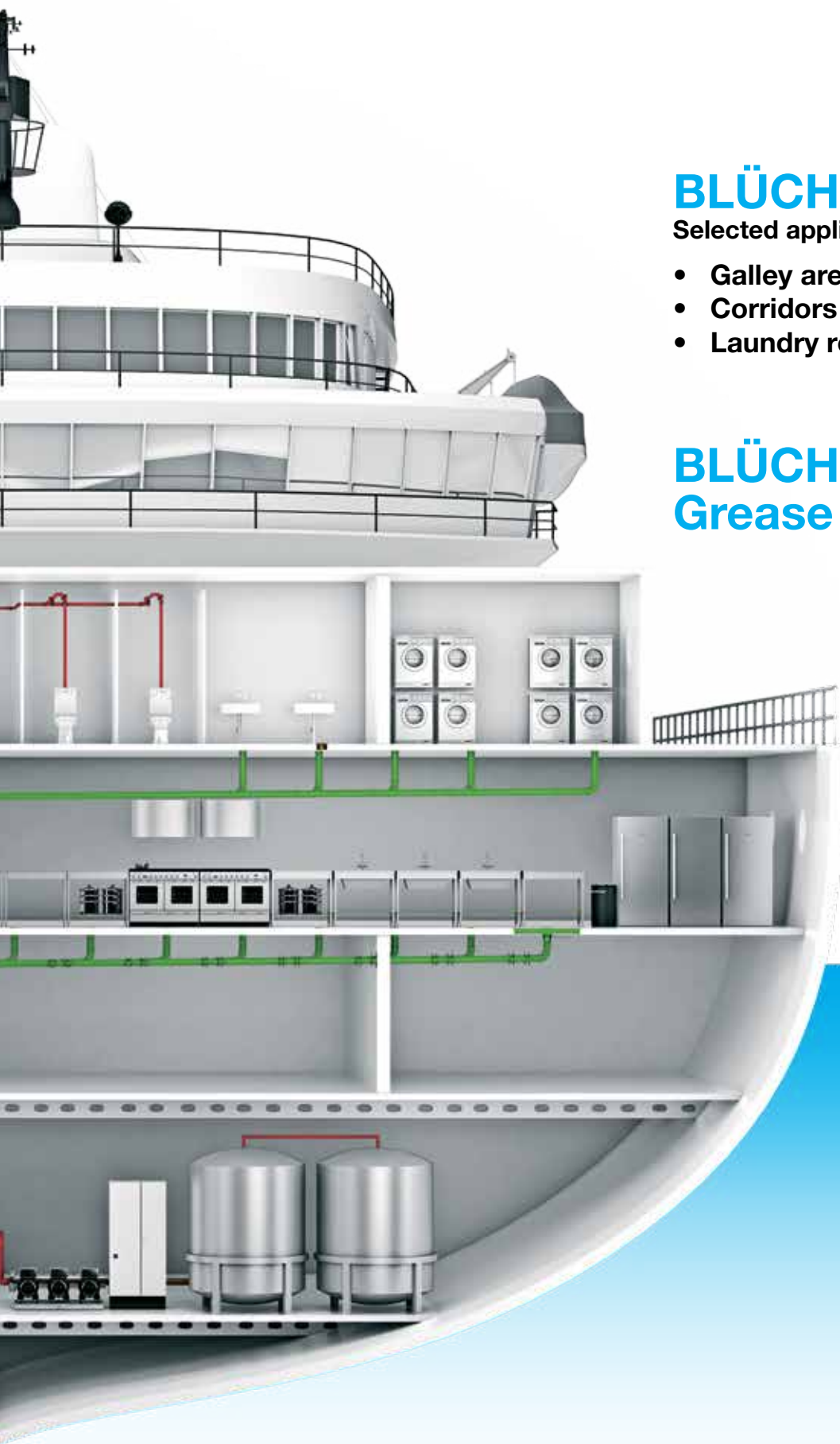

**BLÜCHER®**

A WATTS Brand

# APPROVALS AND CERTIFICATES

BLÜCHER® sanitary discharge system meets the highest demands within testing and approvals. BLÜCHER® holds the MED certification and type approvals of the leading classification authorities. See which ones below.

The certificates can be found and downloaded at [www.blucher-marine.com](http://www.blucher-marine.com)

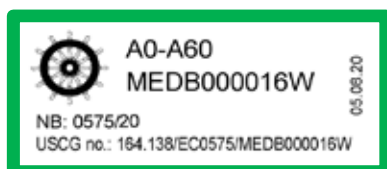
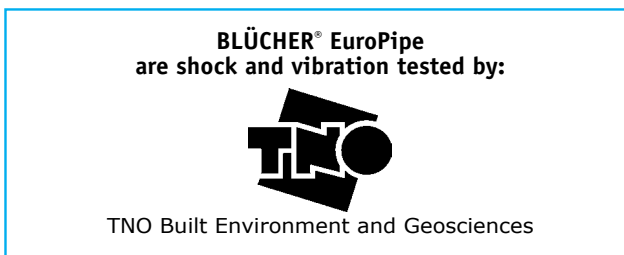
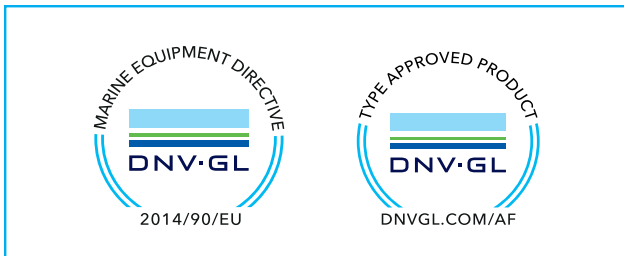

**Mark of Conformity:** In general, all seals/penetrations installed onboard a vessel, must bear the steering wheel approval mark. In addition to the normal product labelling, all fire approved products from BLÜCHER are labelled with a special approval label showing the steering wheel and other relevant information.



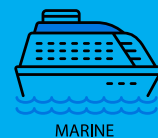

## BLÜCHER® EUROPIPE - THE ADVANTAGES AT A GLANCE

- All in stainless steel - AISI 316L/EN1.4404 or AISI 304/EN1.4301
- Available in OD 40, 50, 75, 110, 125, 160 and 200 mm in standard lengths from 0,15 to 6 meters
- Fast and simple installation due to push-fit socket and spigot end jointing
- Low weight of material (only 1-1,5 mm wall thickness), yet strong
- Completely interchangeable between vacuum and gravity installations
- 100% pressure tested from factory
- Non-combustible, classified as A1
- Complete range of approvals
- Fire tested A0-A60
- Long product-life expectancy
- Hygienic – low surface roughness, high flow capacity, no bacterial growth
- Recyclable
- Complete range of fittings
- Customized solutions available on request
- Easily combined with other pipe materials
- Easy maintenance
- One complete system from one supplier
- Shock and vibration tested



## DIMENSIONAL DRAWING, SOCKET AND SPIGOT END

## PIPES AND FITTINGS

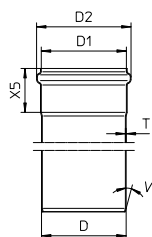

Type no.	EAN no.	D	D1	D2	X5	T	V (°)
811.XXX.040		40	41	52	41	1	20
811.XXX.050		50	51	61	42	1	20
811.XXX.075		75	76	87	50	1	20
811.XXX.110		110	111	123	57	1	20
811.XXX.125		125	126	140	60	1	20
811.XXX.160		160	161	177	72	1.25	20
811.XXX.200		200	201	219	90	1.5	20

## STRAIGHT PIPE WITH ONE SOCKET TYPE 811

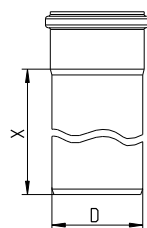

Type no.	EAN no.	D	X	Kg
811.015.040 S	5705499412642	40	150	0,20
811.025.040 S	5705499412666	40	250	0,29
811.050.040 S	5705499412680	40	500	0,68
811.075.040 S	5705499412703	40	750	0,78
811.100.040 S	5705499412727	40	1000	1,02
811.150.040 S	5705499412741	40	1500	1,50
811.200.040 S	5705499412765	40	2000	1,99
811.300.040 S	5705499412789	40	3000	2,96
811.400.040 S	5705499412802	40	4000	3,92
811.500.040 S	5705499412826	40	5000	4,89
811.600.040 S	5705499412840	40	6000	5,86
-----	-----	-----	-----	-----
811.015.050 S	5705499400212	50	150	0,25
811.025.050 S	5705499400298	50	250	0,38
811.050.050 S	5705499400373	50	500	0,68
811.075.050 S	5705499400458	50	750	1,00
811.100.050 S	5705499400533	50	1000	1,25
811.150.050 S	5705499400618	50	1500	1,90
811.200.050 S	5705499400694	50	2000	2,45
811.300.050 S	5705499400786	50	3000	3,82
811.400.050 S	5705499400861	50	4000	5,06
811.500.050 S	5705499400946	50	5000	6,31
811.600.050 S	5705499401028	50	6000	7,56
-----	-----	-----	-----	-----
811.015.075 S	5705499400236	75	150	0,41
811.025.075 S	5705499400311	75	250	0,58
811.050.075 S	5705499400397	75	500	1,00
811.075.075 S	5705499400472	75	750	1,50
811.100.075 S	5705499400557	75	1000	1,95
811.150.075 S	5705499400632	75	1500	2,75
811.200.075 S	5705499400717	75	2000	3,70
811.300.075 S	5705499400809	75	3000	5,78
811.400.075 S	5705499400885	75	4000	7,66
811.500.075 S	5705499400960	75	5000	9,54
811.600.075 S	5705499401042	75	6000	11,42
-----	-----	-----	-----	-----
811.015.110 S	5705499400250	110	150	0,61
811.025.110 S	5705499400335	110	250	0,87
811.050.110 S	5705499400410	110	500	1,50
811.075.110 S	5705499400496	110	750	2,15
811.100.110 S	5705499400571	110	1000	2,85
811.150.110 S	5705499400656	110	1500	4,30
811.200.110 S	5705499400731	110	2000	5,40
811.300.110 S	5705499400823	110	3000	8,34
811.400.110 S	5705499400908	110	4000	11,26
811.500.110 S	5705499400984	110	5000	14,00
811.600.110 S	5705499401066	110	6000	16,78
-----	-----	-----	-----	-----
811.015.125 S	5705499410846	125	150	0,70
811.025.125 S	5705499408225	125	250	1,01
811.050.125 S	5705499408249	125	500	1,78
811.075.125 S	5705499408256	125	750	2,55
811.100.125 S	5705499408270	125	1000	3,32
811.150.125 S	5705499408294	125	1500	4,86
811.200.125 S	5705499408317	125	2000	6,40
811.300.125 S	5705499408324	125	3000	9,47
811.400.125 S	5705499410921	125	4000	12,55

Continues on next page

## STRAIGHT PIPE WITH ONE SOCKET TYPE 811

Type no.	EAN no.	D	X.	Kg
Continued from previous page				
811.500.125 S	5705499410945	125	5000	15,63
811.600.125 S	5705499410969	125	6000	18,71
-----				
811.015.160 S	5705499400274	160	150	1,16
811.025.160 S	5705499400359	160	250	1,69
811.050.160 S	5705499400434	160	500	2,96
811.075.160 S	5705499400519	160	750	4,22
811.100.160 S	5705499400595	160	1000	5,48
811.150.160 S	5705499400670	160	1500	8,02
811.200.160 S	5705499400755	160	2000	10,54
811.300.160 S	5705499400847	160	3000	15,59
811.400.160 S	5705499400922	160	4000	20,64
811.500.160 S	5705499401004	160	5000	25,69
811.600.160 S	5705499401080	160	6000	30,74
-----				
811.015.200 S	5705499411522	200	150	1,96
811.025.200 S	5705499411539	200	250	2,77
811.050.200 S	5705499410853	200	500	4,62
811.075.200 S	5705499411546	200	750	6,47
811.100.200 S	5705499410877	200	1000	8,32
811.200.200 S	5705499410884	200	2000	15,71
811.300.200 S	5705499410891	200	3000	23,10



- Bends

**BEND 15° TYPE 820.015**

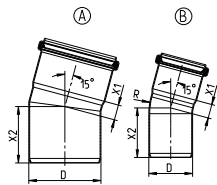

Type no.	EAN no.	D	X1	X2	R	Kg	Ver.
820.015.040 S	5705499412864	40	15	53	40	0,12	B
820.015.050 S	5705499401134	50	16	57	75	0,15	B
820.015.075 S	5705499401158	75	20	66	100	0,28	B
820.015.110 S	5705499401172	110	25	78	110	0,47	B
820.015.125 S	5705499408614	125	19	84	-	0,56	A
820.015.160 S	5705499401196	160	29	99	-	1,08	A
820.015.200 S	5705499410976	200	31	123	-	1,99	A

**BEND 22.5° TYPE 820.023**

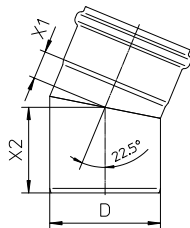

Type no.	EAN no.	D	X1	X2	Kg
820.023.050 S	5705499408621	50	15	57	0,15
820.023.075 S	5705499401219	75	21	71	0,29
820.023.110 S	5705499408638	110	28	85	0,51
820.023.160 S	5705499408645	160	39	109	1,18

**BEND 30° TYPE 820.030**

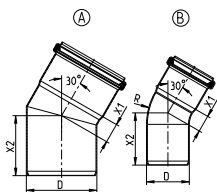

Type no.	EAN no.	D	X1	X2	R	Kg	Ver.
820.030.040 S	5705499412888	40	18	55	40	0,13	B
820.030.050 S	5705499401233	50	20	61	75	0,16	B
820.030.075 S	5705499401257	75	25	75	100	0,28	B
820.030.110 S	5705499401271	110	33	86	110	0,51	B
820.030.125 S	5705499408669	125	28	98	-	0,63	A
820.030.160 S	5705499401295	160	40	109	-	1,15	A
820.030.200 S	5705499410983	200	45	137	-	2,20	A

**BEND 45° TYPE 820.045**

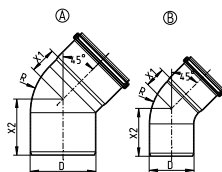

Type no.	EAN no.	D	X1	X2	R	Kg	Ver.
820.045.040 S	5705499412901	40	21	58	40	0,13	A
820.045.050 S	5705499401318	50	27	64	75	0,17	B
820.045.075 S	5705499401332	75	34	80	100	0,30	B
820.045.110 S	5705499401356	110	44	94	110	0,56	A
820.045.125 S	5705499408683	125	58	111	125	0,73	A
820.045.160 S	5705499401370	160	57	128	172	1,55	A
820.045.200 S	5705499414011	200	61	151	200	2,38	A

**BEND 87.5° TYPE 820.090**

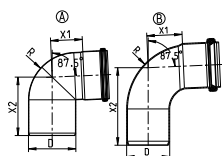

Type no.	EAN no.	D	X1	X2	R	Kg	Ver.
820.090.040 S	5705499412925	40	32	79	40	0,16	A
820.090.050 S	5705499401394	50	41	90	75	0,21	B
820.090.075 S	5705499401417	75	54	108	75	0,39	A
820.090.110 S	5705499401431	110	74	136	110	0,67	A
820.090.125 S	5705499408737	125	93	161	125	1,68	A
820.090.160 S	5705499401455	160	103	184	164	2,10	A

Continues on next page

- Bends

**BEND 87.5° TYPE 820.090**

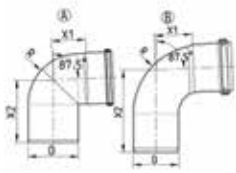

Type no.	EAN no.	D	X1	X2	R	Kg	Ver.
Continued from previous page							
820.090.200 S	5705499414042	200	116	216	200	3,00	A

**BEND 89° TYPE 820.090**

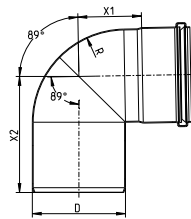

Type no.	EAN no.	D	X1	X2	R	Kg
820.090.050 AS	5705499408690	50	42	88	50	0,21
820.090.075 AS	5705499408706	75	55	109	75	0,39
820.090.110 AS	5705499408713	110	75	137	110	0,67
820.090.160 AS	5705499408744	160	105	185	164	2,10

**BEND, LONG RADIUS 87.5°, 50 MM TYPE 821.000**

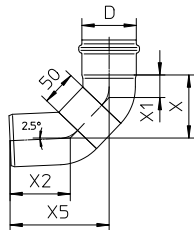

Type no.	EAN no.	D	X	X1	X2	X5	Kg
821.000.050 S	5705499404012	50	77	26	72	120	0,30
821.000.075 S	5705499404036	75	90	32	86	141	0,50

**BEND, LARGE RADIUS 45° TYPE 825.045**

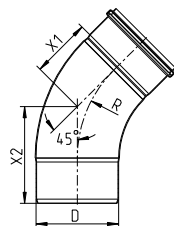

Type no.	EAN no.	D	X1	X2	R	Kg
825.045.200 S	5705499410990	200	144	234	300	4,18
825.045.250 S	5705499121612	250	187	280	375	6,53
825.045.315 S	5705499413830	315	204	320	400	10,78

**BEND, LARGE RADIUS 87.5° TYPE 825.090**

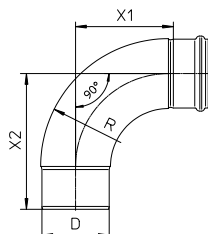

Type no.	EAN no.	D	X1	X2	R	Kg
825.090.200 S	5705499411423	200	307	397	300	6,41

- Branches

BRANCH 87.5° TYPE 830

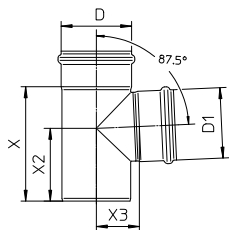

Type no.	EAN no.	D	D1	X	X2	X3	Kg
830.040.040 S	5705499412949	40	40	101	69	30	0,22
830.040.050 S	5705499412963	50	40	106	71	35	0,26
830.050.050 S	5705499401615	50	50	106	71	35	0,27
830.050.075 S	5705499401639	75	50	139	98	49	0,44
830.050.110 S	5705499401653	110	50	132	93	66	0,64
830.075.075 S	5705499401691	75	75	139	90	52	0,50
830.075.110 S	5705499401714	110	75	152	104	69	0,76
830.075.125 S	5705499408959	125	75	187	110	77	0,94
830.110.110 S	5705499401738	110	110	183	117	69	0,88
830.110.125 S	5705499408980	125	110	205	127	77	1,25
830.110.160 S	5705499401752	160	110	236	152	93	1,83
830.125.125 S	5705499409017	125	125	220	135	82	1,17
830.160.160 S	5705499401776	160	160	288	184	104	2,40
830.160.200 S	5705499411003	200	160	293	186	125	3,45
830.200.200 S	5705499411010	200	200	333	206	128	4,17

DOUBLE BRANCH 87.5° TYPE 831

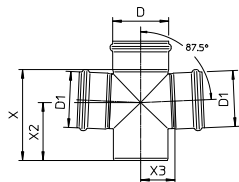

Type no.	EAN no.	D	D1	X	X2	X3	Kg
831.050.050 S	5705499401790	50	50	106	71	35	0,36
831.050.075 S	5705499401813	75	50	139	98	49	0,54
831.050.110 S	5705499401837	110	50	132	93	66	0,72
831.075.075 S	5705499401851	75	75	139	90	52	0,66
831.075.110 S	5705499401875	110	75	152	104	69	0,89
831.110.110 S	5705499401899	110	110	183	116	69	1,13
831.110.160 S	5705499401912	160	110	236	152	94	2,05
831.160.160 S	5705499401936	160	160	288	184	104	2,91

DOUBLE BRANCH 87.5° TYPE 832

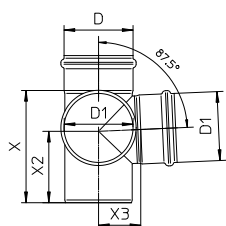

Type no.	EAN no.	D	D1	X	X2	X3	Kg
832.050.050 S	5705499401950	50	50	106	71	35	0,36
832.050.075 S	5705499401974	75	50	139	98	49	0,54
832.050.110 S	5705499401998	110	50	132	93	66	0,72
832.075.075 S	5705499402018	75	75	139	90	52	0,66
832.075.110 S	5705499402032	110	75	152	104	69	0,89
832.110.110 S	5705499402056	110	110	183	116	69	1,13
832.110.160 S	5705499402070	160	110	236	152	94	2,07
832.160.160 S	5705499402094	160	160	288	184	104	2,91



- Branches

**DOUBLE BRANCH 45° TYPE 836**

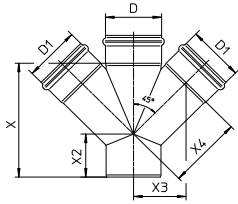

Type no.	EAN no.	D	D1	X	X2	X3	X4	Kg
836.050.050 S	5705499402117	50	50	128	57	54	76	0,59
836.050.075 S	5705499402131	75	50	144	56	66	94	0,69
836.050.110 S	5705499402155	110	50	147	42	84	119	0,80
836.075.075 S	5705499402179	75	75	183	78	78	110	1,15
836.075.110 S	5705499402193	110	75	182	60	95	135	1,31
836.110.110 S	5705499402216	110	110	233	88	105	149	2,10
836.110.125 S	5705499412574	125	110	250	90	110	155	1,65
836.110.160 S	5705499402223	160	110	258	80	131	186	2,85
836.125.125 S	5705499412581	125	125	273	103	120	170	2,10
836.160.160 S	5705499402230	160	160	331	120	156	221	5,28
836.200.200 S	5705499412598	200	200	415	151	194	274	5,28

**DOUBLE BRANCH 45° TYPE 837**

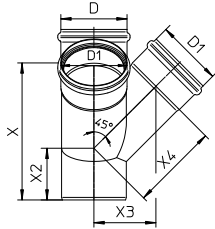

Type no.	EAN no.	D	D1	X	X2	X3	X4	Kg
837.050.050 S	5705499402254	50	50	128	57	54	76	0,49
837.050.075 S	5705499402278	75	50	144	56	66	94	0,67
837.050.110 S	5705499402285	110	50	147	42	84	119	0,92
837.075.075 S	5705499402292	75	75	183	74	78	110	1,43
837.075.110 S	5705499402308	110	75	182	60	95	135	1,31
837.110.110 S	5705499402322	110	110	233	88	105	149	2,07
837.110.160 S	5705499402339	160	110	258	80	131	186	2,07
837.160.160 S	5705499402346	160	160	331	120	156	221	4,02

**OBLIQUE BRANCH 45° TYPE 838**

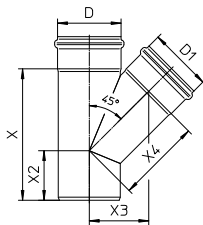

Type no.	EAN no.	D	D1	X	X2	X3	X4	Kg
838.040.040 S	5705499413007	40	40	118	58	45	63	0,25
838.040.050 S	5705499413021	50	40	119	55	50	71	0,30
838.050.050 S	5705499402360	50	50	133	62	54	76	0,32
838.050.075 S	5705499402384	75	50	144	56	66	94	0,48
838.050.110 S	5705499402407	110	50	147	42	84	119	0,70
838.075.075 S	5705499402421	75	75	183	78	78	110	0,64
838.075.110 S	5705499402445	110	75	181	60	95	135	0,88
838.075.125 S	5705499409321	125	75	200	65	100	141	1,32
838.110.110 S	5705499402469	110	110	236	91	105	149	1,16
838.110.125 S	5705499409345	125	110	250	90	110	155	1,50
838.110.160 S	5705499402483	160	110	258	80	131	186	2,11
838.125.125 S	5705499409369	125	125	273	103	120	170	1,49
838.160.160 S	5705499402506	160	160	331	120	156	220	3,04
838.160.200 S	5705499411027	200	160	359	123	177	250	4,37
838.200.200 S	5705499411034	200	200	415	151	194	274	5,47

**SWEPT BRANCH 87.5° TYPE 839**

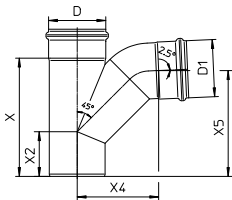

Type no.	EAN no.	D	D1	X	X2	X4	X5	Kg
839.050.050 S	5705499402520	50	50	133	62	84	121	0,44
839.050.075 S	5705499402544	75	50	144	56	97	128	0,60
839.050.110 S	5705499402568	110	50	147	42	115	132	0,81
839.075.075 S	5705499402582	75	75	183	78	114	160	0,87
839.075.110 S	5705499402605	110	75	182	60	130	160	1,11
839.110.110 S	5705499402629	110	110	236	91	161	212	1,64
839.110.160 S	5705499402643	160	110	258	80	186	227	2,53
839.160.160 S	5705499402667	160	160	331	120	223	298	4,52
839.200.200 S	5705499412611	200	200	415	151	428	434	6,13

## - Access pipes and bends

## BEND 87.5° WITH ACCESS TYPE 822

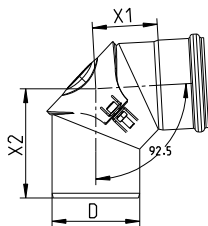

Type no.	EAN no.	D	X1	X2	Kg
822.090.075 S	5705499401516	75	57	102	0,61
822.090.110 S	5705499401530	110	81	137	0,96
822.090.160 S	5705499401554	160	112	205	1,97

## PIPE WITH ACCESS TYPE 840

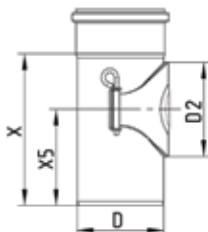

Type no.	EAN no.	D	D2	X	X5	Kg
840.050.050 S	5705499140064	50	55	115	80	0,38
840.075.075 S	5705499402681	75	80	139	92	0,64
840.110.110 S	5705499403800	110	120	194	123	0,90
840.111.110 S	5705499402704	110	120	253	187	1,15
840.125.125 S	5705499411058	125	120	195	128	1,28
840.160.160 S	5705499402728	160	120	277	208	2,41
840.200.200 S	5705499412215	200	120	288	208	3,45

- Sockets

**DOUBLE COUPLING TYPE 841**

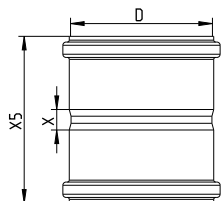

Type no.	EAN no.	D	X	X5	Kg
841.040.040 S	5705499413045	40	20	104	0,13
841.050.050 S	5705499402742	50	13	97	0,15
841.075.075 S	5705499402766	75	20	120	0,26
841.110.110 S	5705499402780	110	16	130	0,45
841.125.125 S	5705499409482	125	20	140	0,54
841.160.160 S	5705499402803	160	20	162	1,05
841.200.200 S	5705499411065	200	20	200	1,85

**DOUBLE SLIP COUPLING TYPE 842**

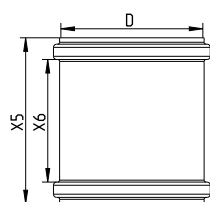

Type no.	EAN no.	D	X5	X6	Kg
842.040.040 S	5705499413069	40	104	76	0,13
842.050.050 S	5705499402810	50	97	71	0,12
842.075.075 S	5705499402827	75	120	91	0,21
842.110.110 S	5705499402834	110	130	97	0,45
842.125.125 S	5705499409550	125	140	104	0,47
842.160.160 S	5705499402841	160	162	118	1,05
842.200.200 S	5705499411072	200	200	147	1,82

**EXPANSION SOCKET TYPE 843**

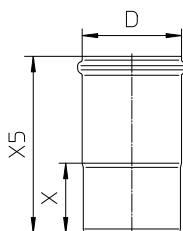

Type no.	EAN no.	D	X	X5	Kg
843.095.040 S	5705499413083	40	55	150	0,17
843.105.050 S	5705499402865	50	57	159	0,21
843.115.075 S	5705499402889	75	62	175	0,36
843.125.110 S	5705499402902	110	79	200	0,57
843.140.125 S	5705499122510	125	100	240	0,81
843.182.160 S	5705499402926	160	122	292	1,55

**EXPANSION SOCKET, LONG MODEL TYPE 869**

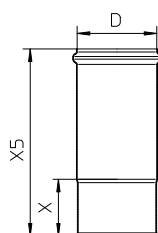

Type no.	EAN no.	D	X	X5	Kg
869.143.050 S	5705499410624	50	57	200	0,25
869.163.075 S	5705499410648	75	62	225	0,40
869.181.110 S	5705499410662	110	79	260	0,70
869.200.125 S	5705499412208	125	100	300	0,99
869.238.160 S	5705499410686	160	122	360	1,85
869.300.200 S	5705499121353	200	120	420	2,43

## - Increasers and reducers

## INCREASER ECCENTRIC TYPE 850

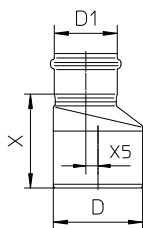

Type no.	EAN no.	D	D1	X	X5	Kg
850.040.050 S	5705499413397	50	40	85	5	0,16
850.050.075 S	5705499403091	75	50	87	7	0,22
850.050.110 S	5705499403114	110	50	114	25	0,38
850.075.110 S	5705499403152	110	75	116	15	0,42
850.075.160 S	5705499403176	160	75	178	37	1,20
850.110.125 S	5705499413410	125	110	109	8	0,49
850.110.160 S	5705499403213	160	110	140	22	1,06
850.125.160 S	5705499413427	160	125	138	18	0,95
850.160.200 S	5705499413434	200	160	165	20	1,67

## INCREASER CONCENTRIC TYPE 850

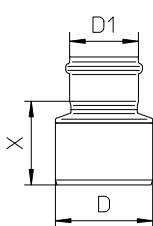

Type no.	EAN no.	D	D1	X	Kg
850.040.050 CS	5705499413991	50	40	65	0,13
850.050.075 CS	5705499409734	75	50	82	0,20
850.050.110 CS	5705499408454	110	50	94	0,30
850.075.110 CS	5705499409741	110	75	95	0,37
850.110.125 CS	5705499409758	125	110	103	0,52
850.110.160 CS	5705499408461	160	110	117	1,00
850.125.160 CS	5705499408478	160	125	145	1,00
850.160.200 CS	5705499411096	200	160	170	1,50

## REDUCER ECCENTRIC TYPE 850

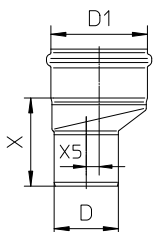

Type no.	EAN no.	D	D1	X	X5	Kg
850.075.050 S	5705499403121	50	75	80	7	0,28
850.110.050 S	5705499403183	50	110	99	25	0,50
850.110.075 S	5705499403190	75	110	104	15	0,55
850.125.110 S	5705499413359	110	125	96	8	1,00
850.160.110 S	5705499408485	110	160	123	22	1,08
850.160.125 S	5705499413366	125	160	136	18	0,50
850.200.160 S	5705499413373	160	200	153	20	1,77

## REDUCER CONCENTRIC TYPE 850

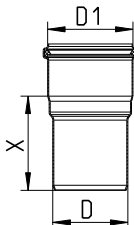

Type no.	EAN no.	D	D1	X	Kg
850.050.032 S	5705499403053	32	50	52	0,15
850.082.075 CS	5705499413465	75	82	94	1,00

- Adaptors

**FEMALE ADAPTOR TYPE 885.0**

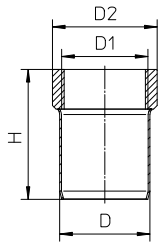

Type no.	EAN no.	D	D1	H.	D2	Kg
885.032.040 S	5705499403954	40	1¼"	75	45	0,20
885.040.040 S	5705499403947	40	1½"	83	57	0,20
885.025.050 S	5705499403435	50	1"	98	40	0,18
885.032.050 S	5705499403459	50	1¼"	77	48	0,17
885.040.050 S	5705499403466	50	1½"	77	58	0,19
885.050.050 S	5705499403473	50	2"	88	67	0,22

BSP thread.

**MALE ADAPTOR TYPE 886.0**

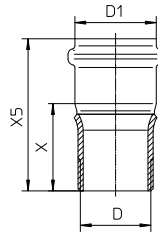

Type no.	EAN no.	D (")	D1	X	X5	Kg
886.050.032 S	5705499403480	1¼	50	55	97	0,25
886.050.040 S	5705499403497	1½	50	56	98	0,23
886.050.050 S	5705499403503	2	50	56	98	0,27

BSP thread.

**UNIVERSAL FLANGE TYPE 854.500**

WITH SOCKET

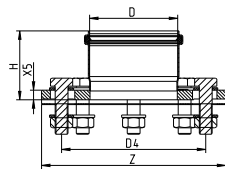

Type no.	EAN no.	D	Z.	H.	D4	X5	Kg
854.500.040 S	5705499139594	40	Ø160	74	94-126	10	0,85
854.500.050 S	5705499138870	50	Ø160	68	94-126	10	0,85
854.500.075 S	5705499138894	75	Ø200	81	129-161	12	1,49
854.500.110 S	5705499138917	110	Ø230	86	163-192	12	2,16
854.500.125 S	5705499138931	125	Ø255	94	198-217	15	3,28
854.500.160 S	5705499138955	160	Ø285	112	228-244	15	3,72

Flanges with 4 screw joints (D=40-75mm)  
Flanges with 8 screw joints (D=110-160mm)

**UNIVERSAL FLANGE TYPE 854.510**

WITH SPIGOT

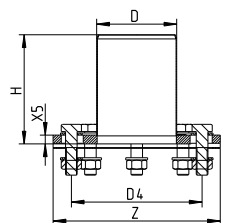

Type no.	EAN no.	D	Z.	H.	D4	X5	Kg
854.510.040 S	5705499139600	40	Ø160	150	94-126	10	0,91
854.510.050 S	5705499138887	50	Ø160	150	94-126	10	0,95
854.510.075 S	5705499138900	75	Ø200	150	129-161	12	1,61
854.510.110 S	5705499138924	110	Ø230	150	163-192	12	2,32
854.510.125 S	5705499138948	125	Ø255	150	198-217	15	3,43
854.510.160 S	5705499138962	160	Ø285	150	228-244	15	3,72

Flanges with 4 screw joints (D=40-75mm)  
Flanges with 8 screw joints (D=110-160mm)



## - Adaptors

## ADAPTOR FROM BLÜCHER PIPE TO OTHER PIPE SYSTEM (SYSTEM-X)

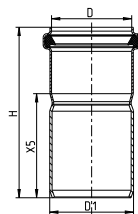

Type no.	EAN no.	D	D1	H	X5	Kg
859.040.042 S	5705499140101	40	42.4	87	45	0,12
859.050.053 S	5705499140118	50	53	108	66	0,16
859.075.073 S	5705499140125	75	73	135	85	0,24
859.110.102 S	5705499140132	110	101.6	150	93	0,57

## ADAPTOR FROM OTHER PIPE SYSTEM (SYSTEM-X) TO BLÜCHER PIPE

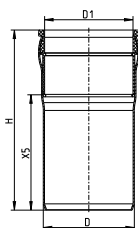

Type no.	EAN no.	D	D1	H	X5	Kg
859.053.050 S	5705499140149	50	53	105	61	0,22
859.073.075 S	5705499140156	75	73	148	95	0,40
859.102.110 S	5705499140163	110	101.6	175	110	0,94

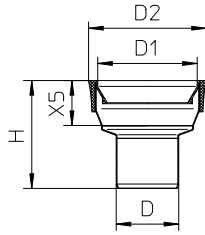
**- Toilet adaptors****TOILET ADAPTOR STRAIGHT TYPE 855.090**

Type no.	EAN no.	D	D1	H.	D2	X5	Kg
855.090.110 S	5705499403305	110	110	126	133	55	0,39

## - Others

## TRANSPORT POCKET TYPE 873

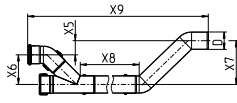

Type no.	EAN no.	D	X5	X6	X7	X8	X9	Kg
873.000.050 S	5705499131727	50	61	93	154	809	1224	2,16
873.000.075 S	5705499131734	75	61	128	188	819	1344	4,63

## GOOSE NECK TYPE 874

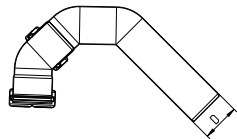

Type no.	EAN no.	D	Kg
874.000.050 S	5705499131703	50	0,78
874.000.075 S	5705499131710	75	1,38

Clamps

PIPE JOINT CLAMP TYPE 847



Type no.	EAN no.	D
847.040.040	5705499413090	40
847.050.050	5705499412420	50
847.075.075	5705499412437	75
847.110.110	5705499412444	110
847.125.125	5705499412451	125
847.160.160	5705499412468	160
847.200.200	5705499412475	200

Clamps are recommended to be used at each deck/bulkhead penetration and drain for marine installations.

Also available in stainless steel AISI316L/EN1.4404 on request.

PRESSURE PEAK PIPE JOINT CLAMP TYPE 847.001

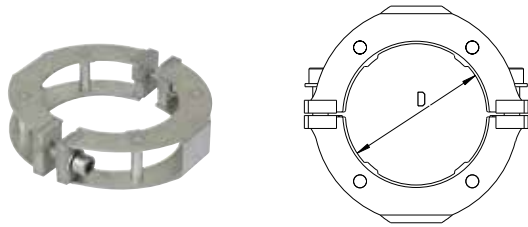

Type no.	EAN no.	D
847.001.040	5705499413106	40
847.001.050	5705499412499	50
847.001.075	5705499412505	75
847.001.110	5705499412529	110
847.001.125	5705499412536	125
847.001.160	5705499412543	160
847.001.200	5705499413939	200

Pipework can withstand brief pressure peaks when fitted with pressure peak joint clamps on all joints.

Not to be used instead of remotely operated valve.

Pipe hangers

PIPE HANGER WITH EPDM RUBBER TYPE 895.012

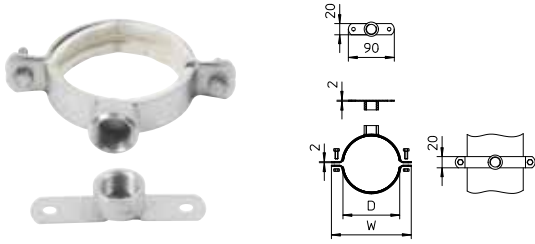

Type no.	EAN no.	D	W
895.012.040 GS	5705499413113	40	90
895.012.050 GS	5705499403558	50	101
895.012.075 GS	5705499403565	75	126
895.012.110 GS	5705499403572	110	161
895.012.160 GS	5705499403589	160	211

With 1/2" BSP thread.

PIPE HANGER WITH EPDM RUBBER TYPE 895.200

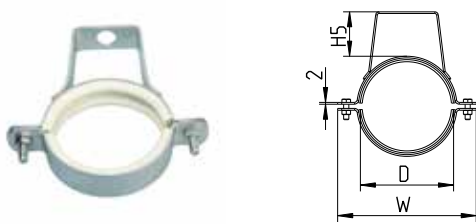

Type no.	EAN no.	D	H5.	W
895.200.040 S	5705499413120	40	38	90
895.200.050 S	5705499410747	50	38	101
895.200.075 S	5705499410754	75	54	126
895.200.110 S	5705499410761	110	52	161
895.200.160 S	5705499410778	160	71	211

PIPE HANGER WITH EPDM RUBBER TYPE 895.300



Type no.	EAN no.	D	W
895.300.040 GS	5705499413137	40	90
895.300.050 GS	5705499403633	50	101
895.300.075 GS	5705499403640	75	126
895.300.110 GS	5705499403657	110	161
895.300.160 GS	5705499403664	160	211

PIPE HANGER WITH EPDM RUBBER TYPE 895.401  
IN GALVANIZED STEEL

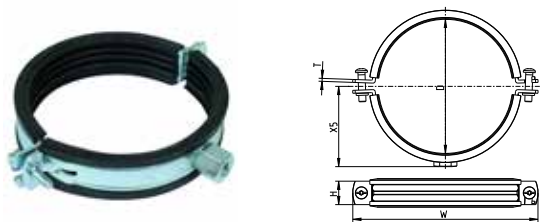

Type no.	EAN no.	D	H.	W	X5	T	Nut
895.401.040	8712993164059	40	20	91	45	1.25	M8/M10
895.401.050	8712993164066	50	20	97	48	1.25	M8/M10
895.401.075	8712993164103	75	20	125	62	1.5	M8/M10
895.401.110	8712993164141	110	23	164	81	2	M8/M10
895.401.125	8712993164158	125	23	181	89	2	M8/M10
895.401.160	8712993164172	160	23	209	102	2	M8/M10
895.401.200	8712993554386	200	25	269	133	2.5	M8/M10



## Pipe hangers

## PIPE HANGER WITH EPDM RUBBER TYPE 895.403

IN STAINLESS STEEL

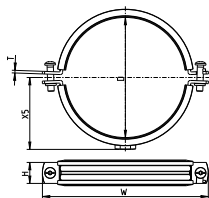

Type no.	EAN no.	D	H.	W	X5	T	Nut
895.403.040 S	5705499413168	40	20	87	35	1.25	M8
895.403.050 S	5705499128161	50	20	96	39	1.25	M8
895.403.075 S	5705499128178	75	20	118	51	2	M8
895.403.110 S	5705499128185	110	20	158	72	2.5	M10
895.403.125 S	5705499128192	125	20	170	78	2.5	M10
895.403.160 S	5705499128208	160	25	233	101	2.5	M10
895.403.200 S	5705499128215	200	25	273	120	2.5	M10

D=75mm fits D=82mm as well.

Plugs

SOCKET PLUG TYPE 844.000

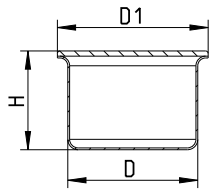

Type no.	EAN no.	D	D1	H.
844.000.040 S	5705499413175	40	50	47
844.000.050 S	5705499402933	50	58	38
844.000.075 S	5705499402940	75	85	45
844.000.110 S	5705499402957	110	120	45
844.000.125 S	5705499412222	125	135	43
844.000.160 S	5705499402964	160	170	43
844.000.200 S	5705499412239	200	210	50

Use of pipe joint clamp type 847 is necessary if any pressure in the pipe system is expected.

SOCKET PLUG TYPE 844

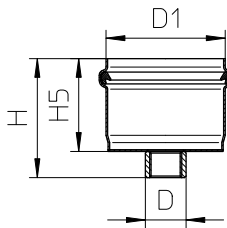

Type no.	EAN no.	D (")	D1	H.	H5.
844.069.050	5705499409567	½	50	67	50
844.082.075	5705499409574	½	75	78	61
844.087.110	5705499409581	½	110	84	67

BSP thread.  
For pressure testing.

SOCKET PLUG TYPE 844.100

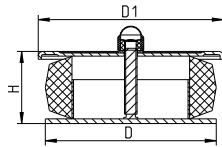

Type no.	EAN no.	D	D1	H.
844.100.050 S	5705499411393	50	59	31
844.100.075 S	5705499411409	75	83	36
844.100.110 S	5705499411416	110	118	46

Use of pipe joint clamp type 847 is recommended if the pressure in the pipe system is expected to exceed 0.5 bar for D<110mm and 0.3 bar for D=110mm.

SOCKET PLUG TYPE 845.000

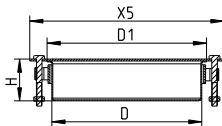

Type no.	EAN no.	D	D1	H.	X5
845.000.160 S	5705499403008	160	170	45	207

## Sealing rings

**EPDM LIP SEALING RING BLACK TYPE 801**

FOR STANDARD USE

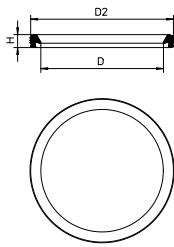

Type no.	EAN no.	D	H	D2
801.EPDM.040	5705499403930	40	7.8	51.7
801.EPDM.050	5705499400038	50	7.8	61.8
801.EPDM.075	5705499400045	75	7.8	87.1
801.EPDM.110	5705499400069	110	8.9	124.2
801.EPDM.125	5705499408096	125	10.2	142.3
801.EPDM.160	5705499400076	160	11.5	180.1
801.EPDM.200	5705499410785	200	12.8	223.8

**FPM LIP SEALING RING TYPE 801**

FOR HIGH TEMPERATURES

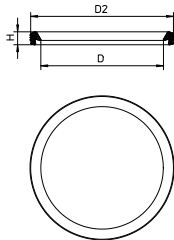

Type no.	EAN no.	D	H	D2
801.FPM.040	5705499413458	40	7.8	51.7
801.FPM.050	5705499408102	50	7.8	61.8
801.FPM.075	5705499408119	75	7.8	87.1
801.FPM.110	5705499408126	110	8.9	124.2
801.FPM.125	5705499410792	125	10.2	142.3
801.FPM.160	5705499408133	160	11.5	180.1
801.FPM.200	5705499410808	200	12.8	223.8

**NBR LIP SEALING RING BLACK/YELLOW TYPE 801**

FOR USE WITH OIL

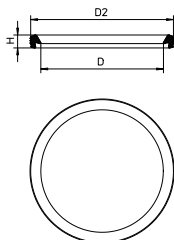

Type no.	EAN no.	D	H	D2
801.NBR.040	5705499413182	40	7.8	51.7
801.NBR.050	5705499400106	50	7.8	61.8
801.NBR.075	5705499400113	75	7.8	87.1
801.NBR.110	5705499400120	110	8.9	124.2
801.NBR.125	5705499410815	125	10.2	142.3
801.NBR.160	5705499400137	160	11.5	180.1
801.NBR.200	5705499410822	200	12.8	223.8

**SI LIP SEALING TYPE 801**

FOR USE IN FIRE-APPROVED PRODUCTS

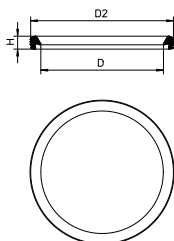

Type no.	EAN no.	D	H	D2
801.SI.040	5705499413199	40	7.8	51.7
801.SI.050	5705499408140	50	7.8	61.8
801.SI.075	5705499408157	75	7.8	87.1
801.SI.110	5705499408164	110	8.9	124.2
801.SI.125	5705499138795	125	10.2	142.3
801.SI.160	5705499408171	160	11.5	180.1

## for steel decks and bulkheads

**PENETRATION TYPE 866**

WITH SLEEVE FOR WELDING

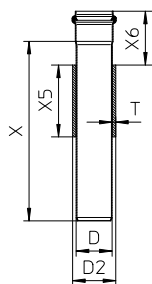

Type no.	EAN no.	EC/MED (Bulkhead)	EC/MED (Deck)	D	D2	X	X5	X6	T	Kg
866.015.040.05FS	5705499140620	A0-A60	A0-A60	40	50	150	50	75	5	0,47
866.015.050.05FS	5705499140651	A0-A60	A0-A60	50	60	150	50	75	5	0,56
866.015.075.05FS	5705499140675	A0-A60	A0-A60	75	85	150	50	75	5	0,85
866.015.110.05FS	5705499140699	A0-A60	A0-A60	110	120	150	50	75	5	1,26
866.015.125.05FS	5705499140712	A0-A60	A0-A60	125	135	150	50	75	5	1,52
866.015.160.05FS	5705499140743	A0-A60	A0-A60	160	170	150	50	80	5	2,22
866.015.200.05FS	5705499140767	A0-A60	A0-A60	200	210	150	50	110	5	3,23
-----	-----	-----	-----	-----	-----	-----	-----	-----	-----	-----
866.025.040.10FS	5705499413267	A0-A60	A0-A60	40	50	250	100	75	5	0,85
866.025.050.10FS	5705499410099	A0-A60	A0-A60	50	60	250	100	75	5	1,02
866.025.075.10FS	5705499411126	A0-A60	A0-A60	75	85	250	100	75	5	1,50
866.025.110.10FS	5705499411140	A0-A60	A0-A60	110	120	250	100	75	5	2,20
866.025.125.10FS	5705499129397	A0-A60	A0-A60	125	135	250	100	75	5	2,64
866.025.160.10FS	5705499411171	A0-A60	A0-A60	160	170	250	100	80	5	3,80
866.025.200.10FS	5705499413328	A0-A60	A0-A60	200	210	250	100	110	5	5,25

Also available in other lengths on request.

**PENETRATION FOR WASH BASIN TYPE 866.032**

WITH SLEEVE FOR WELDING

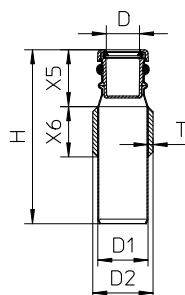

Type no.	EAN no.	EC/MED (Bulkhead)	EC/MED (Deck)	D	D1	H.	D2	X5	X6	T	Kg
866.032.050.05 S	5705499403992	A0-A60	A0-A60	32	50	173	60	57	50	5	0,60

Inlet diameter can be changed to D=40mm

for steel decks and bulkheads

**TOILET PENETRATION FOR VACUUM SYSTEM TYPE 867**

WITH SLEEVE FOR WELDING

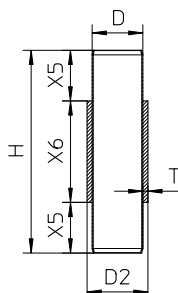

Type no.	EAN no.	EC/MED (Bulkhead)	EC/MED (Deck)	D	H.	D2	X5	X6	T	Kg
867.020.040.10 S	5705499413274	A0-A60	A0-A60	40	200	50	50	100	5	0,74
867.020.050.10 S	5705499410549	A0-A60	A0-A60	50	200	60	50	100	5	0,89

**FLANGED PENETRATION TYPE 868**

WITH FLANGE FOR WELDING

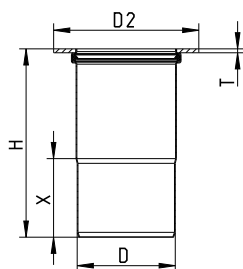

Type no.	EAN no.	EC/MED (Bulkhead)	EC/MED (Deck)	D	H.	D2	X	T	Kg
868.000.040FS	5705499140798	A0-A60	A0-A60	40	97	90	53	5	0,31
868.000.050FS	5705499140828	A0-A60	A0-A60	50	98	100	53	5	0,36
868.000.075FS	5705499140842	A0-A60	A0-A60	75	113	135	61	5	0,61
868.000.110FS	5705499140866	A0-A60	A0-A60	110	128	160	69	5	0,78
868.000.125FS	5705499140880	A0-A60	A0-A60	125	135	185	73	5	1,02
868.000.160FS	5705499140910	A0-A60	A0-A60	160	157	220	85	5	1,55
868.000.200FS	5705499140941	A0-A60	A0-A60	200	200	260	110	5	2,45
-----	-----	-----	-----	-----	-----	-----	-----	-----	-----
868.100.040FS	5705499413281	A0-A60	A0-A60	40	152	90	55	5	0,36
868.105.050FS	5705499411195	A0-A60	A0-A60	50	160	100	57	5	0,40
868.115.075FS	5705499411218	A0-A60	A0-A60	75	176	135	62	5	0,70
868.125.110FS	5705499411232	A0-A60	A0-A60	110	201	160	79	5	0,99
868.140.125FS	5705499139648	A0-A60	A0-A60	125	240	185	100	5	1,36
868.182.160FS	5705499139662	A0-A60	A0-A60	160	292	220	122	5	2,23
868.210.200FS	5705499139686	A0-A60	A0-A60	200	350	260	140	5	3,57

Also available in other lengths on request.



## for steel decks and bulkheads

**PENETRATION TYPE 870**

WITH SLEEVE FOR WELDING

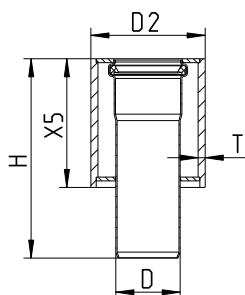

Type no.	EAN no.	EC/MED (Deck)	D	H.	D2	X5	T	Kg
870.000.040FS	5705499413298	A0-A60	40	151	89	100	5	1,45
870.000.050FS	5705499411256	A0-A60	50	155	89	100	5	1,47
870.000.075FS	5705499411270	A0-A60	75	167	108	100	4	1,74
870.000.110FS	5705499412161	A0-A60	110	167	140	100	4	2,29
870.000.125FS	5705499139709	A0-A60	125	175	170	100	5	2,95
870.000.160FS	5705499139723	A0-A60	160	188	195	100	5	3,64
870.000.200FS	5705499139747	A0-A60	200	228	235	120	5	5,57

Only for installation in deck.

**PENETRATION TYPE 872**

WITH WELDING TRANSITION

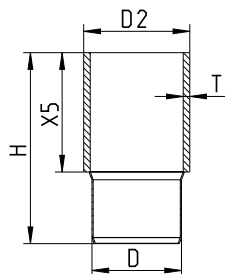

Type no.	EAN no.	EC/MED (Bulkhead)	EC/MED (Deck)	D	H.	D2	X5	T	Kg
872.050.040 S	5705499413304	A0-A60	A0-A60	40	150	50	100	5	0,61
872.060.050 S	5705499411348	A0-A60	A0-A60	50	155	60.3	100	5.5	0,82
872.076.075 S	5705499411355	A0-A60	A0-A60	75	160	76.1	100	5	0,99
872.089.075 S	5705499411362	A0-A60	A0-A60	75	160	88.9	100	5.5	1,25
872.114.110 S	5705499411379	A0-A60	A0-A60	110	155	114.3	100	6	1,77
872.150.125 S	5705499139754	A0-A60	A0-A60	125	186	150	100	5	2,10
872.168.160 S	5705499139761	A0-A60	A0-A60	160	190	168.3	100	3.3	1,79
872.210.200 S	5705499139778	A0-A60	A0-A60	200	210	210.3	100	5	3,37

for steel decks and bulkheads

**PENETRATION TYPE 875**

WITH WELDING TRANSITION

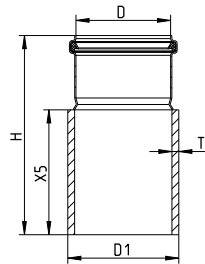

Type no.	EAN no.	EC/MED (Bulkhead)	EC/MED (Deck)	D	D1	H.	X5	T	Kg
875.050.040FS	5705499139792	A0-A60	A0-A60	40	50	150	100	5	0,62
875.060.050FS	5705499139815	A0-A60	A0-A60	50	60.3	149	100	5.5	0,83
875.076.075FS	5705499139839	A0-A60	A0-A60	75	76.1	160	100	5	1,02
875.089.075FS	5705499139853	A0-A60	A0-A60	75	88.9	160	100	5.5	1,27
875.114.110FS	5705499139877	A0-A60	A0-A60	110	114.3	165	100	6	1,84
875.139.110FS	5705499139891	A0-A60	A0-A60	110	139.7	165	100	4	1,61
875.150.125FS	5705499139914	A0-A60	A0-A60	125	150	184	100	5	2,12
875.168.160FS	5705499139938	A0-A60	A0-A60	160	168.3	188	100	3	1,78
875.210.200FS	5705499139952	A0-A60	A0-A60	200	210,5	210	100	5	3,54

**FLANGED PENETRATION TYPE 868.910**

NON-WELDED

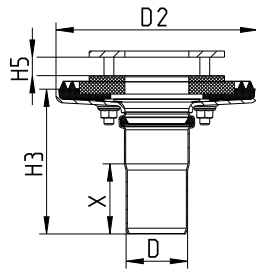

Type no.	EAN no.	EC/MED (Deck)	D	H3	H5	D2	X	Kg
868.910.050 S	5705499139525	A0-A60	50	118	4-15	164	57	3,14
868.910.075 S	5705499139532	A0-A60	75	133	4-15	188	65	3,92
868.910.110 S	5705499139549	A0-A60	110	150	4-15	230	74	5,51
868.910.125 S	5705499139556	A0-A60	125	148	4-15	240	77	5,61
868.910.160 S	5705499139563	A0-A60	160	172	4-15	273	89	7,02

## for aluminium decks and bulkheads

**FLANGED PENETRATION TYPE 878**

WITH BIMETAL FLANGE FOR WELDING

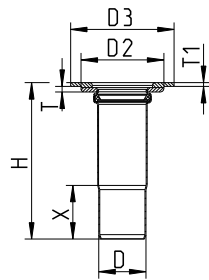

Type no.	EAN no.	EC/MED (Bulkhead)	EC/MED (Deck)	D	H.	D2	D3	X	T	T1	Kg
878.105.050FS	5705499121797	A0-A30	A0-A60	50	166	88	110	57	6	4	0,60
878.115.075FS	5705499121810	A0-A30	A0-A60	75	182	113	136	62	6	4	0,86
878.125.110FS	5705499121834	A0-A30	A0-A60	110	207	148	172	79	6	4	1,27

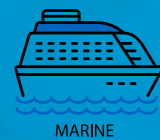

# BLÜCHER® EUROPIPE - TECHNICAL DATA



# JOINTING OF BLÜCHER® EUROPIPE - STEP BY STEP

## 1. Check of lip seal

Check that the lip sealing ring is correctly installed in the socket

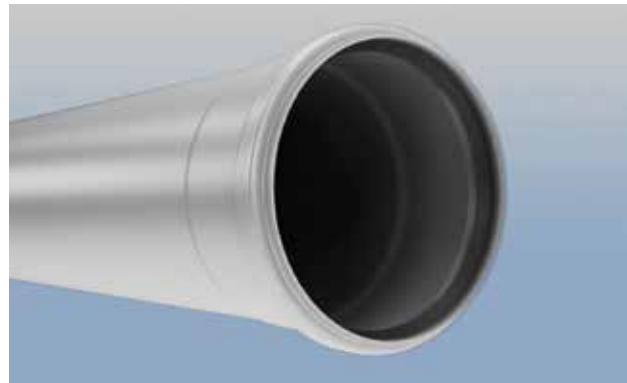

## 2. Cleaning

If necessary clean lip sealing ring, spigot end and socket before jointing

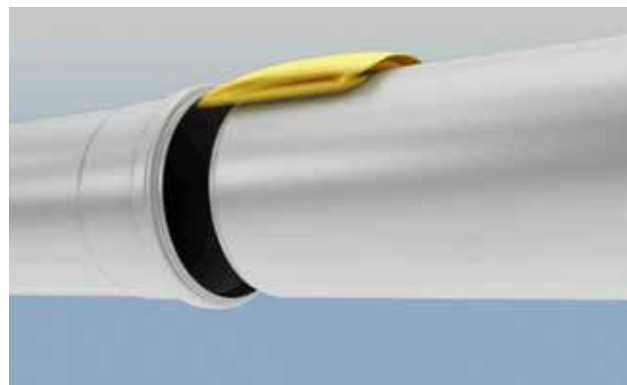

## 3. Mark insertion depth

Mark insertion depth on spigot end of pipe – see max. and min. insertion depth in table (figure 1).

*A “Rule of thumb” is to insert the spigot end all the way in to the maximum depth, and then pull it a couple of mm. back again. This will ensure room for expansion in the pipe system.)*

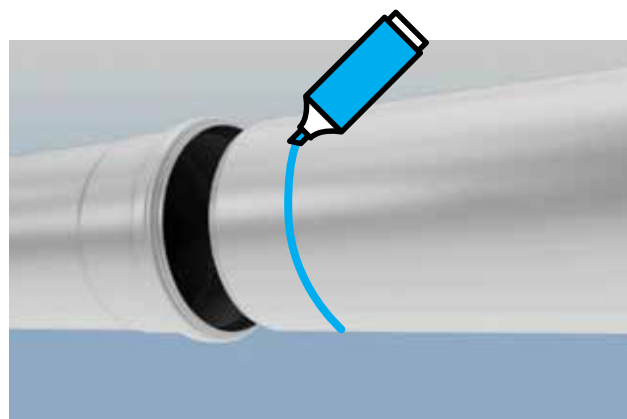
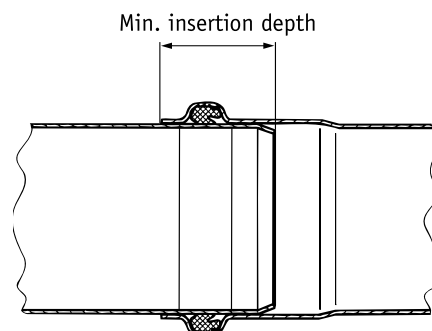

Figure 1 INSERTION DEPTH

Pipe dimension in mm	Max. insertion depth from end of socket to spigot end	Min. insertion depth from end of socket to spigot end
OD 40 mm	46 mm	30 mm
OD 50 mm	47 mm	30 mm
OD 75 mm	55 mm	35 mm
OD110 mm	62 mm	40 mm
OD125 mm	65 mm	47 mm
OD160 mm	76 mm	50 mm
OD200 mm	98 mm	63 mm

Installation videos available at [www.blucher-marine.com](http://www.blucher-marine.com)







#### 4. Apply Lubricant

Apply standard soap based lubricant for normal use (type no. 007.100.050) or silicone based lubricant (type no. 007.200.040) if there may be a requirement to demount the joints at a later date. (See figure 2).

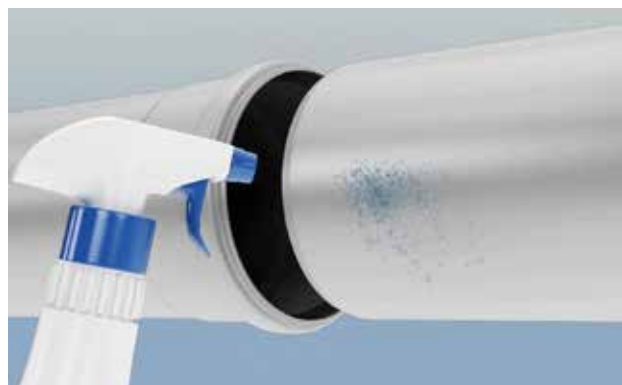

Figure 2 Lubricant and Cutting oil

##### BLÜCHER® Lubricant:

Type No. 007.100.050      1/2 litre soap lubricant  
 Type No. 007.200.040      400 ml silicon lubricant

##### BLÜCHER® Cutting oil:

Type No. 007.500.050      Cutting oil 0.5 L.

Type No. 007.000.000      Atomizer



#### 5. Jointing

Joint the pipes with a slightly turning movement

##### Flexibility

BLÜCHER® EuroPipe joints are flexible up to 2° without this affecting the leakage tightness. This means that the pipework system will remain tight despite minor vibrations, while on the other hand the flexibility in the pipe joints makes pipe installation easy.

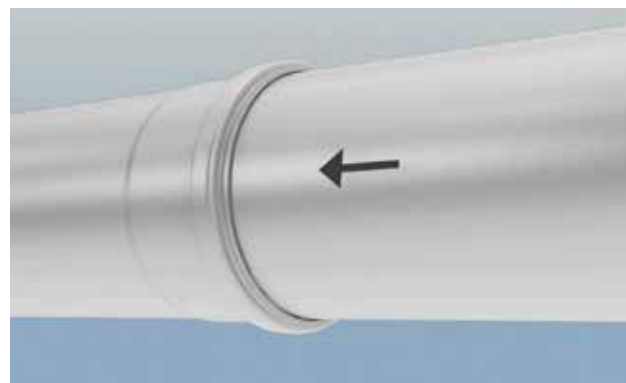

##### Direction of flow

Direction of flow should be from spigot into socket to ensure the correct use of the built-in fall in the fittings. Couplings may be used to fit cut pipe lengths. Normal water flow direction is from spigot end into socket end - but vice versa is also an option.

#### BLÜCHER® assembly tool

For pipe dimensions Ø160 and Ø200 mm assembly tools are available for easy jointing.

Type no.	EAN no.	Designation
806.000.160	5705499124149	For pipes D = 160 mm
806.000.200	5705499123500	For pipes D = 200 mm

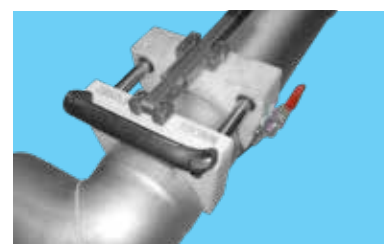

## SUSPENSION OF BLÜCHER® DRAINAGE PIPES

The following section describes the fixing of BLÜCHER® EuroPipe for vertical and horizontal pipe runs.

### VERTICAL PIPING

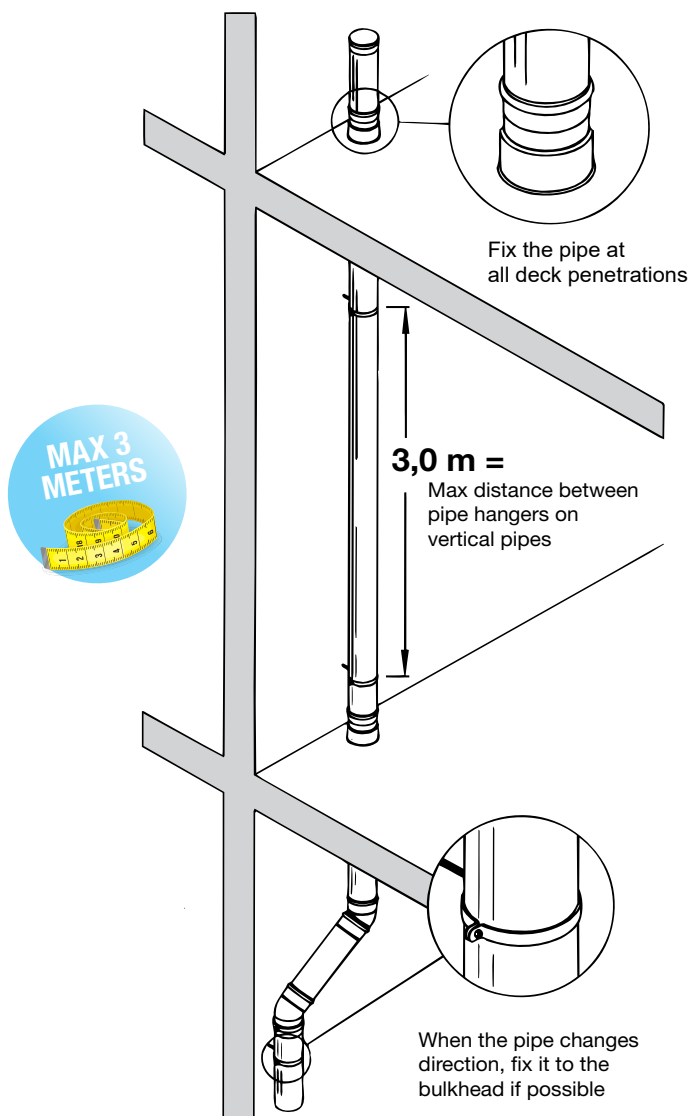

Usually one fixing point per deck is sufficient. As opposed to plastic pipes, stainless steel pipes require only one pipe hanger per 3 metres, resulting in less sound and faster installation.

Where larger inlets are connected, the downpipe must be secured immediately below the inlet.

**THE PIPEWORK SYSTEM MUST BE PROPERLY SUPPORTED AND FIXED TO PREVENT THE SOCKET AND THE SPIGOT END FROM SLIDING APART UNDER ALL ANTICIPATED CONDITIONS.**

### HORIZONTAL PIPING

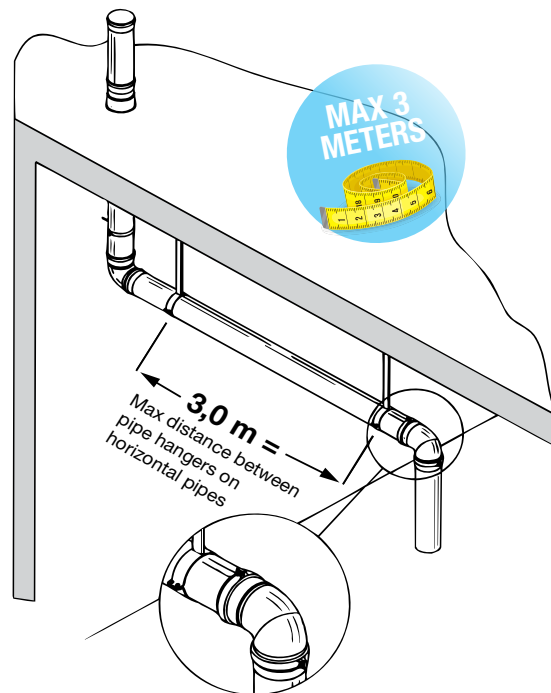

1) Applies to straight horizontal pipelines. If there are fittings or connections in the suspended pipe run (between two hangers), you may need to adjust and reduce the distance to ensure a rigid installation and that the fittings/connections are fully aligned in the center of the pipe run. As an alternative, safety clamps may be installed for added stability.

**Horizontal pipe runs** are always to be installed with a gradient. If no self-cleansing calculation is available, a gradient of 20 ‰ is recommended in gravity systems.

Horizontal pipe runs in vacuum systems are to be installed in accordance with the recommendations of the vacuum system supplier.

**ADDITIONAL PIPE HANGERS ARE REQUIRED AT CHANGE OF DIRECTION I.E. BENDS & BRANCHES TO ANCHOR THE INSTALLATION TO THE STRUCTURE.**

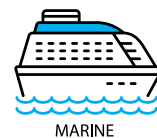

## CUTTING OF BLÜCHER® EUROPIPE

### Cutting

BLÜCHER recommends that cutting of the pipes should be carried out with a BLÜCHER® manual or electric cutting tool.

The BLÜCHER® cutting tools have been specially developed to produce a bevelled leading edge to the cut ends to assure that the pipes can be installed without subsequent finishing and so that the sealing ring will not be damaged by sharp edges.

### Note!

When cutting and jointing BLÜCHER® EuroPipe care should be taken to wear personal protective equipment as required. Work gloves will protect against any potential sharp edges from the cutting process when handling and jointing.

### Manual pipe cutter



### Electrical pipe cutter



Cutting instruction videos and manuals available at [www.blucher-marine.com](http://www.blucher-marine.com)

## BLÜCHER® CUTTING TOOLS

### Cutting quality:

The cutting motion has been developed to produce a bevelled leading edge to cut ends. As a result only the application of BLÜCHER® jointing lubricant is required prior to jointing cut ends.

### Changeover time:

Changeover from one cutting disc to another can be done within a matter of seconds.

### MANUAL PIPE CUTTER

Cutting is carried out by a special disc cutter, which cuts and grips at the same time.

*N.B.: Do not cut fittings.*

Type no.	EAN no.	Designation
006.050.110	5705499000061	Manual pipe cutter (40-110 mm)
006.125.200	5705499001020	Manual pipe cutter (110 - 200 mm)
006.000.005	5705499000023	Spindle for 006.050.110
006.000.000	5705499000016	Cutting disc for 006.050.110
006.000.001	5705499001068	Cutting disc for 006.125.200 & 006.200.315

### ELECTRICAL PIPE CUTTER

Cutting time: Ø50 mm. 10 sec. and Ø110 mm. 10-15 sec.

Power supply: 110 Volt/Min 2 kVA/60 Hz or 220 Volt/50 Hz.

Pipe diametres: 50-160 mm

*N.B.: Do not cut fittings.*

Type no.	EAN no.	Designation
800.050.160	5705499400021	Electrical pipe cutter 220 V
800.050.160 GB	5705499000184	Electrical pipe cutter 110 V, 16 A
800.050.160 US	5705499000191	Electrical pipe cutter 110 V, USA plug
800.030.006	5705499400014	Cutting disc
006.050.160	5705499124132	Support base for electrical pipe cutter



# STAINLESS STEEL – MARINE APPLICATIONS

## Material choice for drainage applications

Stainless steel is a clean, durable, corrosion resistant material with a design life expectancy of over fifty years. The BLÜCHER® sanitary discharge system comes in 2 stainless steel grades, AISI 316L and AISI 304. BLÜCHER normally recommends the use of AISI 316L because the risk of corrosion, caused by an aggressive environment, is significantly reduced or eliminated entirely by choosing the molybdenum stainless steel type AISI 316L. Below are listed the recommended type of material for different applications.

In some products, in which part components are used that are not exposed to sewage water and consequently not affecting the functionality or lifetime of the product, these part components may be made from other materials or alloys than specified for the complete products.

**During installation and until test/normal operation the sanitary discharge system is to be closed and not used in order to avoid contamination by corrosive substances.**

Black water piping	Grey water piping	Grey water piping, Galleys	Deck drain piping	Outside piping visible	Food waste piping
AISI 316L (AISI 304 - Only if no aggressive cleaning agents are used)	AISI 316L (AISI 304 - Only if no aggressive cleaning agents are used)	AISI 316L	AISI 316L*	AISI 316L**	AISI 316L

\* Pipes to be flushed regularly with fresh water

\*\* Outside piping must be primed and painted

## HOW TO DETERMINE MATERIAL QUALITY BY LABEL COLOUR

### Example: AISI 316L - green label



### Example: AISI 304 - red label



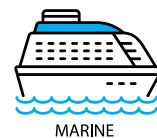

## PRESSURE PERFORMANCE

BLÜCHER® EuroPipe is designed and manufactured in accordance with European standard EN1124, following which it is a vacuum and/or gravity system, not considered a pressure-carrying system. Due to the fact that BLÜCHER® EuroPipe pipes and fittings have push-fit joints, these may potentially slide apart if the system is pressurized.

To prevent such incidents from happening, BLÜCHER offers a range of pipe clamps, all of which are physical restraints designed to keep the pipe joints in place during normal operation and/or to prevent the pipe joints from sliding apart even if an unexpected pressure increase caused by a blockage, for instance from pipe clogging, should result in a temporary pressurization of the system.

The below table states the pressure performance of the BLÜCHER® EuroPipe system.

### BLÜCHER® EuroPipe – pressure performance table

Pipe Size	GRAVITY SYSTEM				VACUUM-SYSTEM
	No * clamp	Pipe Joint Clamp Type 847.XXX.XXX	Pressure Peak Clamp Type 847.001.XXX		
			Permanent design pressure	Pressure Peak	
Ø 40	0,5 bar	2,0 bar	3,0 bar	10,0 bar	-0,85 bar
Ø 50	0,5 bar	2,0 bar	3,0 bar	10,0 bar	-0,85 bar
Ø 75	0,5 bar	2,0 bar	3,0 bar	10,0 bar	-0,85 bar
Ø 110	0,5 bar	2,0 bar	3,0 bar	7,5 bar	-0,60 bar
Ø 125	0,5 bar	1,0 bar	3,0 bar	6,0 bar	-0,60 bar
Ø 160	0,5 bar	1,0 bar	3,0 bar	5,0 bar	-0,60 bar
Ø 200	0,2 bar	0,5 bar	2,5 bar	4,0 bar	-0,60 bar

\* Depending on fixation





## BLÜCHER® DRAINS FOR MARINE APPLICATIONS

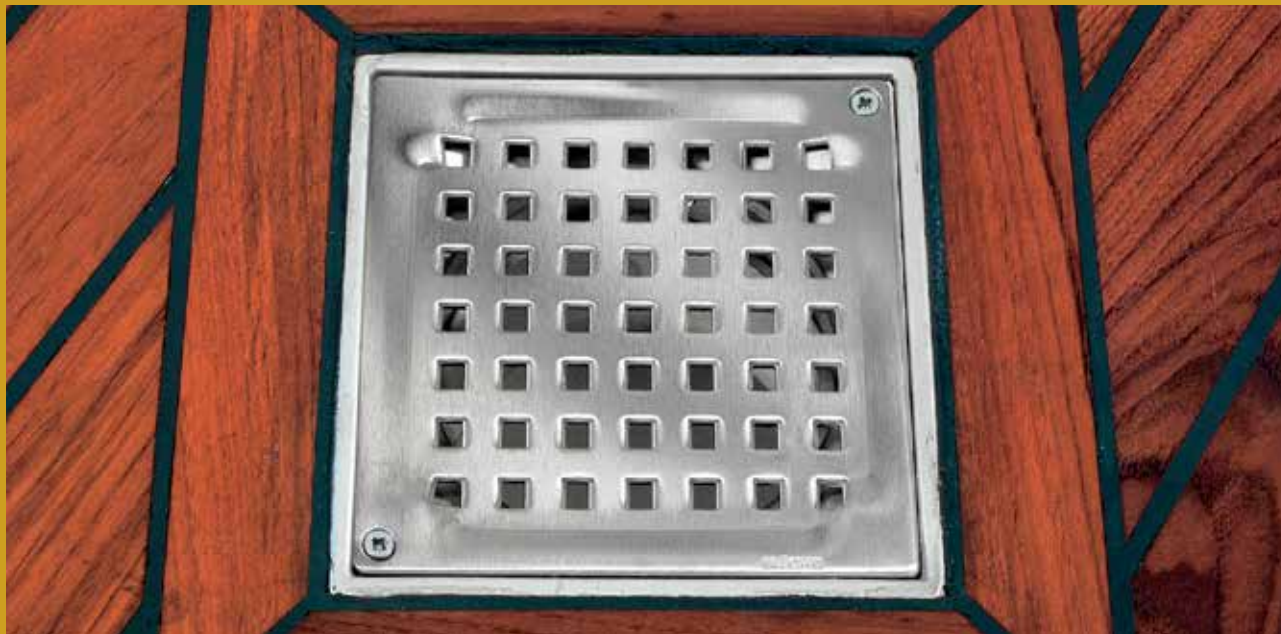

### MULTI-ADJUSTABLE / FOR ANY DECK FINISH / MODULAR SYSTEM

#### Applications

- Showers, toilets, wet cabins, galleys, pantries, deck areas and workshop areas
- Cruise liners, yachts, commercial vessels, navy vessels and off-shore

#### Details

- Protective cover on all lower parts
- Matt-polished surface
- Low 6mm frame height
- Grate with screw lock

- Stainless steel AISI 316L/EN1.4404 or optionally AISI 304/EN1.4301
- Hygienic design

#### Variants

- Side inlets Ø32/Ø40 mm
- Vertical or horizontal outlet
- For welding into deck, with or without welding sleeve, or for installation without welding by means of screw-lock system

#### Options

- Removable water trap
- Design gratings available

#### Series

- Series 47X for stainless steel deck
- Series 48X for aluminium deck

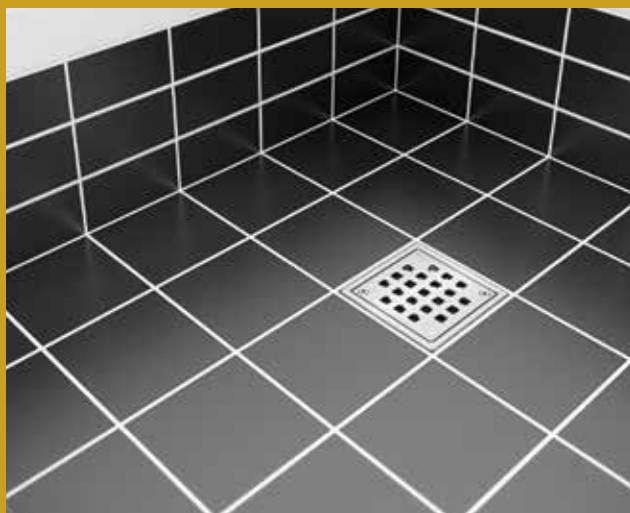

# MARINE DRAINS OVERVIEW

## Combinable drain parts

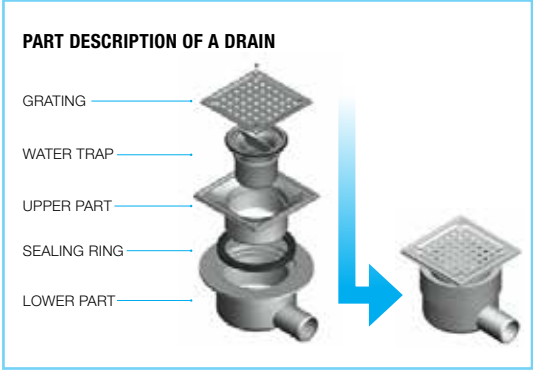
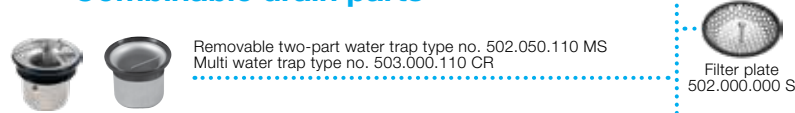

Upper parts

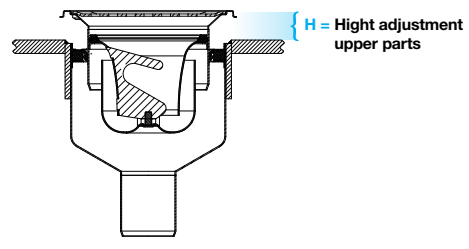
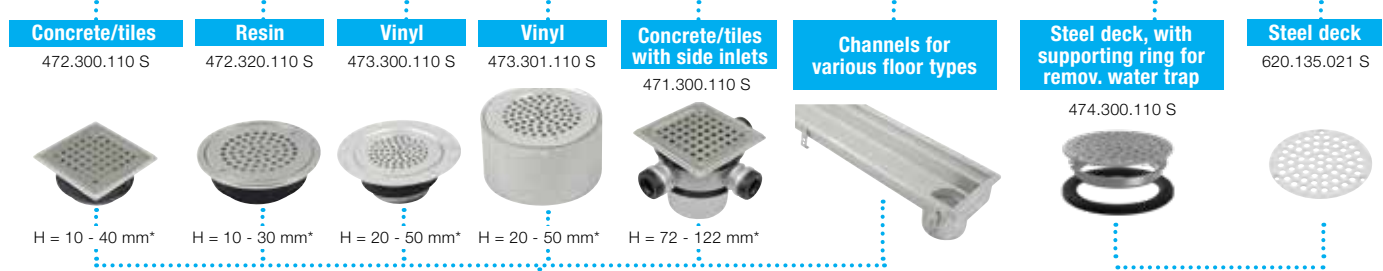

Lower parts

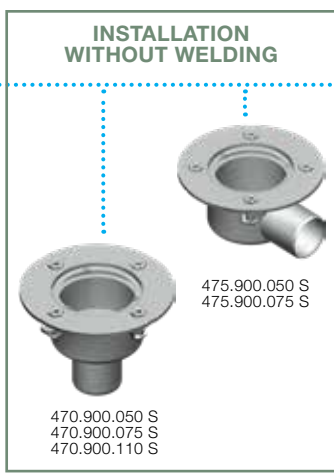
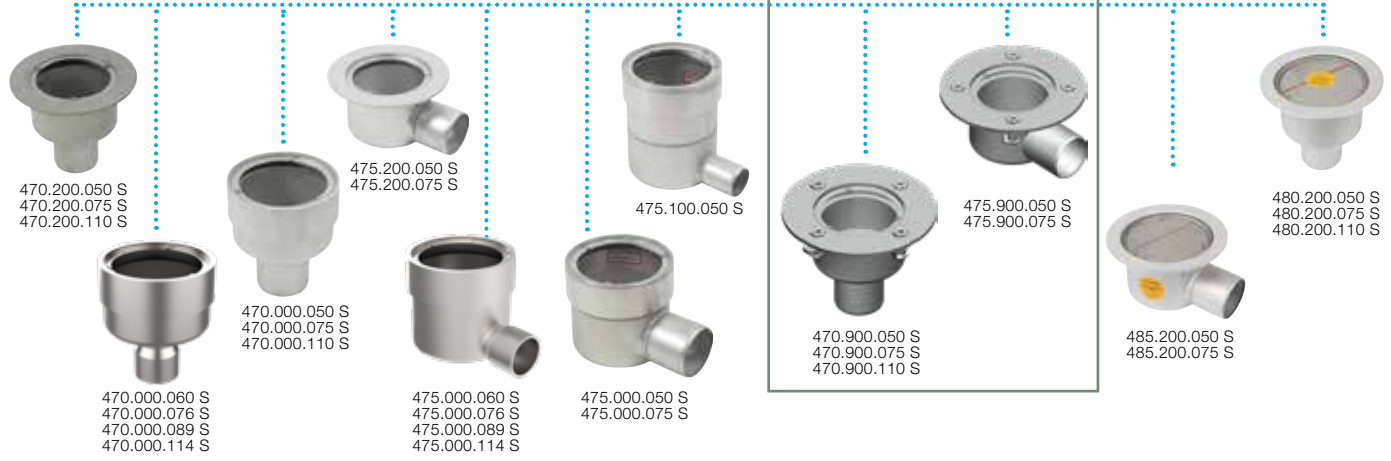

For steel deck/bulkhead

For aluminium deck/bulkhead

Optional gratings for marine drains

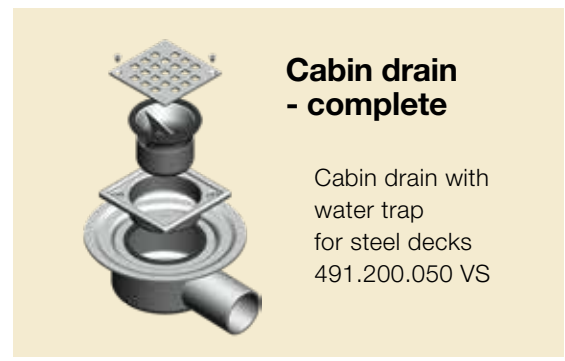
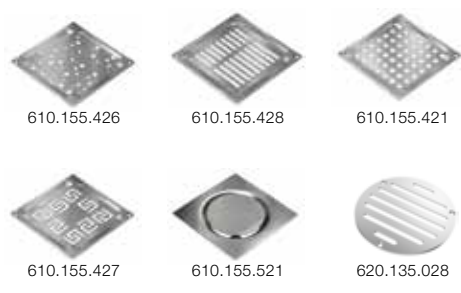



**LOWER PART FOR MARINE DRAIN TYPE 470.000**

WITH WELDING SLEEVE

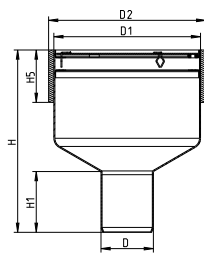

Type no.	EAN no.	EC/MED (Deck)	D	D1	H	H1	H5	D2	Kg
470.000.050 S	5705499106145	A0-A60	50	140	174	58	50	150	1,73
470.000.075 S	5705499106169	A0-A60	75	140	172	63	50	150	1,60
470.000.110 S	5705499106183	A0-A60	110	140	146	75	50	150	1,70

**LOWER PART FOR MARINE DRAIN TYPE 470.000**

WITH WELDING SLEEVE, OUTLET PIPE FOR WELDING

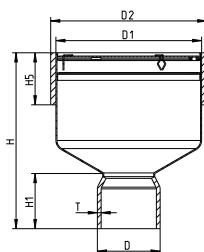

Type no.	EAN no.	EC/MED (Deck)	D	D1	H	H1	H5	D2	T	Kg
470.000.060 S	5705499140521	A0-A60	60.3	140	169	53	50	150	3.6	1,72
470.000.076 S	5705499140538	A0-A60	76.1	140	162	53	50	150	3.6	1,77
470.000.089 S	5705499140545	A0-A60	88.9	140	162	53	50	150	3.2	1,79
470.000.114 S	5705499140552	A0-A60	114.3	140	125	54	50	150	3.0	1,74

**LOWER PART FOR MARINE DRAIN TYPE 470.200**

WITH WELDING FLANGE

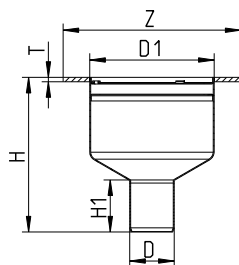

Type no.	EAN no.	EC/MED (Deck)	D	D1	Z	H	H1	T	Kg
470.200.050 S	5705499106206	A0-A60	50	140	Ø200	174	58	5	1,30
470.200.075 S	5705499106220	A0-A60	75	140	Ø200	172	63	5	1,40
470.200.110 S	5705499106244	A0-A60	110	140	Ø200	141	75	5	1,24

**LOWER PART FOR MARINE DRAIN TYPE 475.000**

WITH WELDING SLEEVE

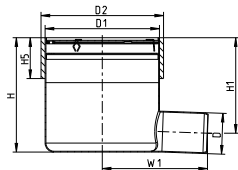

Type no.	EAN no.	EC/MED (Deck)	D	D1	H	H1	H5	W1	D2	Kg
475.000.050 S	5705499106268	A0-A60	50	140	140	117	50	129	150	1,85
475.000.075 S	5705499106282	A0-A60	75	140	140	105	50	134	150	1,80
475.000.110 S	5705499140606	A0-A60	110	140	180	127	50	143	150	1,91

**LOWER PART FOR MARINE DRAIN TYPE 475.000**

WITH WELDING SLEEVE, OUTLET PIPE FOR WELDING

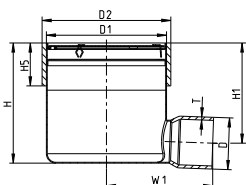

Type no.	EAN no.	EC/MED (Deck)	D	D1	H	H1	H5	W1	D2	T	Kg
475.000.060 S	5705499140569	A0-A60	60.3	140	140	117	50	124	150	3.6	1,87
475.000.076 S	5705499140576	A0-A60	76.1	140	140	104	50	124	150	3.6	1,93
475.000.089 S	5705499140583	A0-A60	88.9	140	140	104	50	124	150	3.2	1,94
475.000.114 S	5705499140590	A0-A60	114.3	140	180	127	50	122	150	3.0	2,13

**LOWER PART FOR MARINE DRAIN, HIGH MODEL TYPE 475.100**

WITH WELDING SLEEVE

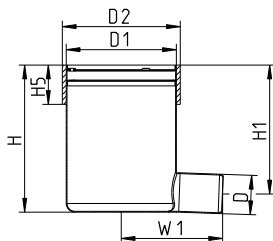

Type no.	EAN no.	EC/MED (Deck)	D	D1	H	H1	H5	W1	D2	Kg
475.100.050 S	5705499106305	A0-A60	50	140	187	164	50	129	150	1,90

**LOWER PART FOR MARINE DRAIN TYPE 475.200**

WITH WELDING FLANGE

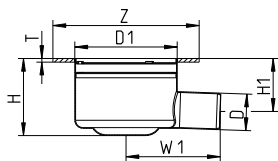

Type no.	EAN no.	EC/MED (Deck)	D	D1	Z	H	H1	W1	T	Kg
475.200.050 S	5705499106329	A0-A60	50	140	Ø200	106	72	129	5	1,30
475.200.075 S	5705499106343	A0-A60	75	140	Ø200	106	71	134	5	1,35

**LOWER PART FOR MARINE DRAIN TYPE 470.900**

NON-WELDED

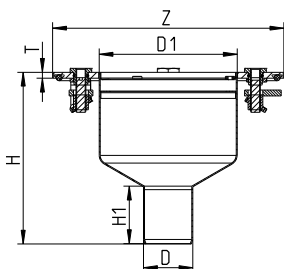

Type no.	EAN no.	EC/MED (Deck)	D	D1	Z	H	H1	T	Kg
470.900.050 S	5705499133318	A0-A60	50	140	Ø235	174	58	6	2,35
470.900.075 S	5705499133325	A0-A60	75	140	Ø235	172	63	6	2,37
470.900.110 S	5705499133332	A0-A60	110	140	Ø235	141	75	6	2,33

**LOWER PART FOR MARINE DRAIN TYPE 475.900**

NON-WELDED

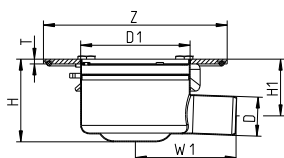

Type no.	EAN no.	EC/MED (Deck)	D	D1	Z	H	H1	W1	T	Kg
475.900.050 S	5705499133349	A0-A60	50	140	Ø235	106	72	129	6	2,35
475.900.075 S	5705499133356	A0-A60	75	140	Ø235	106	71	134	6	2,47

**ADJUSTABLE CABIN DRAIN TYPE 491**

WITH REMOVABLE WATER TRAP

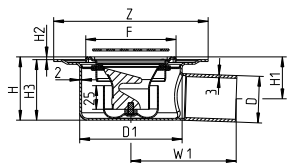

Type no.	EAN no.	EC/MED (Deck)	D	D1	F	Z	H	H1	H2	H3	W1	Kg
491.200.050 VS	5705499131857	A0-A60	50	110	97x97	Ø166	68-78	45-55	3-13	65	113	1,24

**VACUUM DRAIN TYPE 480**

WITH SIDE INLETS

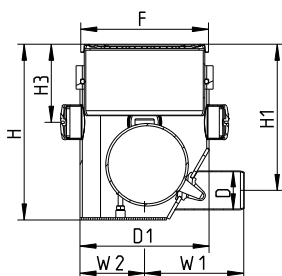

Type no.	EAN no.	D	D1	F	H	H1	H3	W1	W2	Kg
480.150.050	5705499116199	50	166	155x155	217-257	182-220	92-132	128	83	6,07



## STAINLESS STEEL DRAINS AND PENETRATIONS FOR ALUMINIUM STRUCTURES



### Welding directly into aluminium Complete standard system One system - one supplier

#### Applications

The products are suitable in particular for cruise liners, luxury yachts, ferries and other maritime vessels, where high strength combined with low weight is essential.

#### Details

Stainless steel drains and penetrations with a combined aluminium and stainless steel flange. This combination makes it possible to weld stainless steel directly into aluminium decks and bulkheads.

Please also see installation instructions for drains for aluminium structures, no. 760878, or contact BLÜCHER for separate installation instructions.

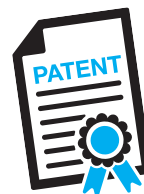

#### Materials

Flange: Stainless steel and aluminium  
Other: Stainless steel - AISI 316L

#### Tests

A salt mist test of the product range has been carried out at the Force Institute in Denmark.

All products are MED approved according to IMO Res. A. 754(18)/IMO 2010 FTP code part 3.

### Installation without welding

Stainless steel drains are also available for installation without welding into aluminium decks.

**LOWER PART FOR MARINE DRAIN TYPE 480**

WITH BIMETAL FLANGE

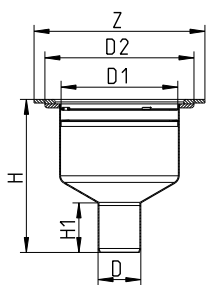

Type no.	EAN no.	EC/MED (Deck)	D	D1	Z	H	H1	D2	Kg
480.200.050 S	5705499121841	A0-A60	50	140	Ø200	179	58	175	1,00
480.200.075 S	5705499121858	A0-A60	75	140	Ø200	177	63	175	1,50
480.200.110 S	5705499121889	A0-A60	110	140	Ø200	151	75	175	1,50

**LOWER PART FOR MARINE DRAIN TYPE 485**

WITH BIMETAL FLANGE

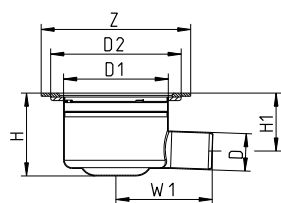

Type no.	EAN no.	EC/MED (Deck)	D	D1	Z	H	H1	W1	D2	Kg
485.200.050 S	5705499121865	A0-A60	50	140	Ø200	111	78	128	175	1,50
485.200.075 S	5705499121872	A0-A60	75	140	Ø200	111	76	133	175	1,56

**LOWER PART FOR MARINE DRAIN TYPE 470.900**

NON-WELDED

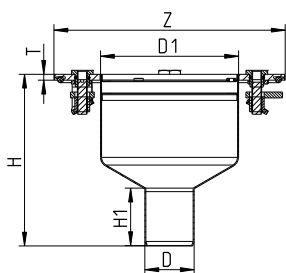

Type no.	EAN no.	EC/MED (Deck)	D	D1	Z	H	H1	T	Kg
470.900.050 S	5705499133318	A0-A60	50	140	235	174	58	6	2,35
470.900.075 S	5705499133325	A0-A60	75	140	235	172	63	6	2,37
470.900.110 S	5705499133332	A0-A60	110	140	235	141	75	6	2,33



**LOWER PART FOR MARINE DRAIN TYPE 475.900**

NON-WELDED

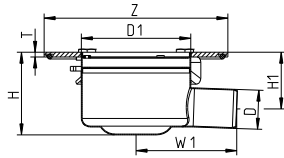

Type no.	EAN no.	EC/MED (Deck)	D	D1	Z	H	H1	W1	T	Kg
475.900.050 S	5705499133349	A0-A60	50	140	235	106	72	129	6	2,35
475.900.075 S	5705499133356	A0-A60	75	140	235	106	71	134	6	2,47

**UPPER PART FOR MARINE DRAIN TYPE 471.300**  
WITH SIDE INLETS

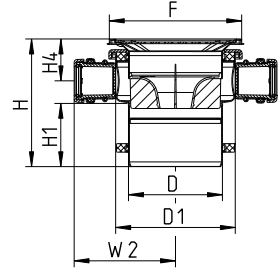

Type no.	EAN no.	D	D1	F	H	H1	H4	W2	Kg
471.300.110 S	5705499106367	110	140	155	150-160	74	49-59	119	3,00

3 inlets (Ø32/40mm)

**UPPER PART FOR MARINE DRAIN TYPE 472.300**

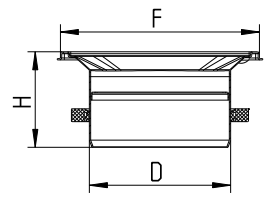

Type no.	EAN no.	D	F	H	Kg
472.300.110 S	5705499106381	110	155x155	74	0,70

**UPPER PART FOR MARINE DRAIN TYPE 472.310**

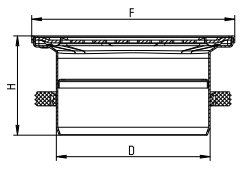

Type no.	EAN no.	D	F	H
472.310.110 S	5705499141610	Ø110	145	71

**UPPER PART FOR MARINE DRAIN TYPE 471.310**

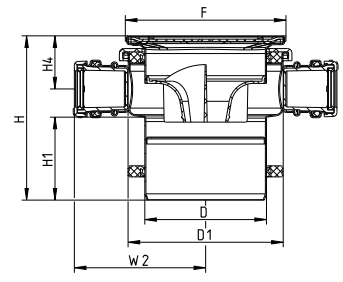

Type no.	EAN no.	D	D1	F	H	H1	H4	W2
471.310.110 S	5705499141603	Ø110	Ø140	145	149-159	75	48-58	119

UPPER PART FOR MARINE DRAIN TYPE 472.320

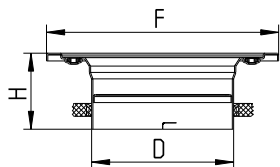

Type no.	EAN no.	D	F	H	Kg
472.320.110 S	5705499118537	110	Ø180	59	0,57

## UPPER PART FOR MARINE DRAIN TYPE 473.300

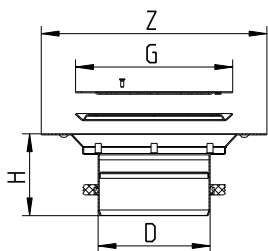

Type no.	EAN no.	D	Z	G	H	Kg
473.300.110 S	5705499106404	110	Ø222	Ø155	81	0,80

## UPPER PART FOR MARINE DRAIN TYPE 473.301

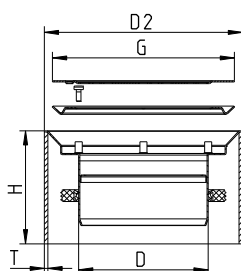

Type no.	EAN no.	D	G	H	D2	T	Kg
473.301.110 S	5705499107517	110	Ø155	96	168	3	0,80

For welding into floating decks

**GRATING SQUARE VIENNA**

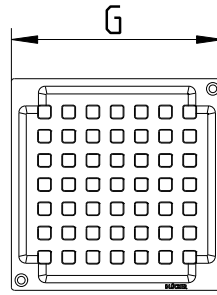

Type no.	EAN no.	G	T	Screws	Kg
610.155.421	5705499102116	140x140	2	2	0,26
610.155.421 S	5705499102130	140x140	2	2	0,26

**GRATING CIRCLE VIENNA**

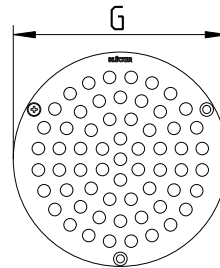

Type no.	EAN no.	G	T	Screws	Kg
620.135.021 S	5705499106466	Ø135	2	3	0,18

**GRATING CIRCLE, 8 MM SLOTS**

FOR BAREFOOT AREAS

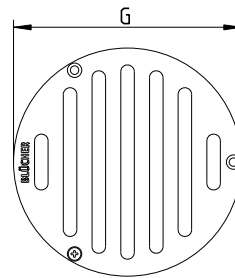

Type no.	EAN no.	G	T	Kg
620.135.028 S	5705499135008	Ø135	2	0,23

If the slots in the grating are to fit in a specific direction, the position of the screw holes in the drain is to be taken into account prior to installation of the drain.

**GRATING CIRCLE VIENNA**

WITH SUPPORTING RING FOR WATER TRAP

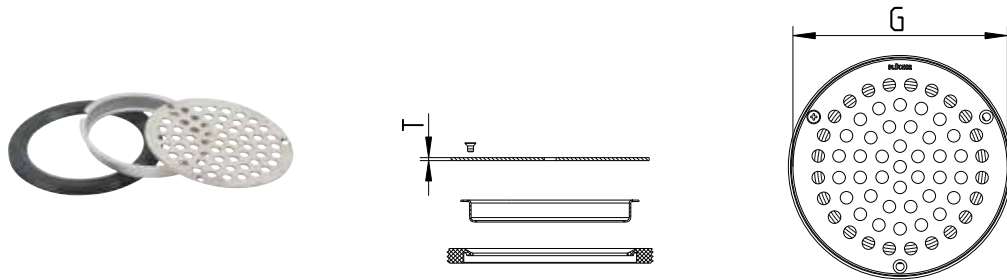

Type no.	EAN no.	G	T	Screws	Kg
474.300.110 S	5705499106428	Ø135	2	3	0,20

**REMOVABLE TWO-PART WATER TRAP TYPE 502.050**

WITH EPDM SEALING RING

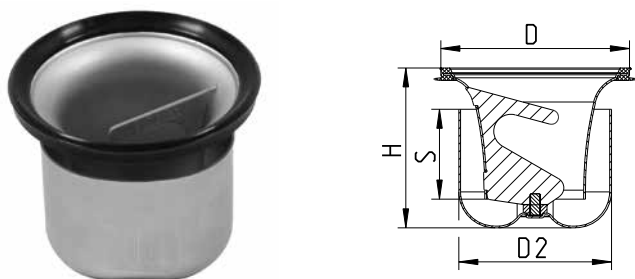

Type no.	EAN no.	D	H	S	D2	Max Flow (l/s)	Kg
502.050.110 MS	5705499133257	108	89	50	85	1.7	0,36

Fits into all drains except type 475.200 and 485.200 produced before 2008.  
Accurate flow rate depending on type of drain and grating.

**REMOVABLE WATER TRAP, LOW MODEL TYPE 502.025**

WITH EPDM SEALING RING



Type no.	EAN no.	D	H	S	D2	Max Flow (l/s)	Kg
502.025.075 S	5705499131833	73	59	25	59	0.4	0,15

Accurate flow rate depending on type of drain and grating.  
Water-seal height does not comply with EN 1253-1 requirements.

**REMOVABLE MULTI WATER TRAP TYPE 503**

WITH CR SEALING RING, PREVENTS SMELL AND BACK FLOW

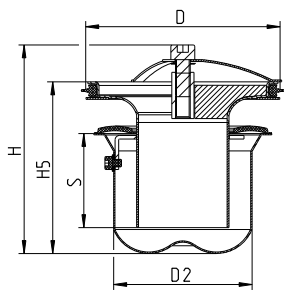

Type no.	EAN no.	D	H	H5	S	D2	Max Flow (l/s)	Kg
503.000.110 CR	5705499131918	108	113	93	51	75	1.2	0,39

Accurate flow rate depending on type of drain and grating.

**REMOVABLE WATER TRAP TYPE 503.001**

PREVENTS SMELL

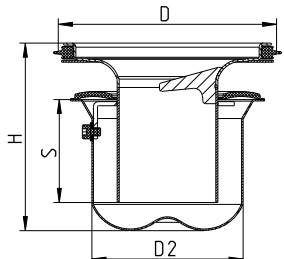

Type no.	EAN no.	D	H	S	D2	Max Flow (l/s)	Kg
503.001.110	5705499134728	108	93	51	75	1.3	0,37

Accurate flow rate depending on type of channel and grating.

**P-TRAP 87,5° TYPE 525**

WITH COUPLING AND DRAIN PLUG

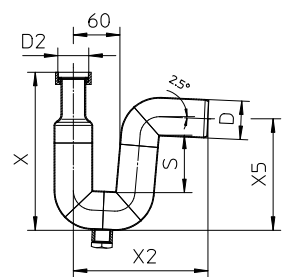

Type no.	EAN no.	D	S	D2	X	X2	X5	Kg
525.032.050 S	5705499114065	50	74	1¼"	205	175	145	0,95
525.040.050 S	5705499114072	50	74	1½"	205	175	145	0,90
525.050.050 S	5705499114089	50	74	2"	205	175	145	0,88

BSP thread.

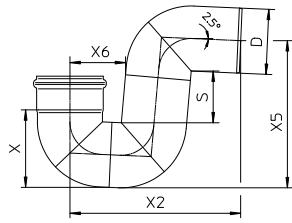

**P-TRAP 87,5° TYPE 525.090**

Type no.	EAN no.	D	S	X	X2	X5	X6	Max Flow (l/s)	Kg
525.090.050 S	5705499101461	50	74	67	175	145	60	1.7	0,45
525.090.075 S	5705499101478	75	81	93	222	189	74	3.7	0,84
525.090.110 S	5705499101485	110	89	132	289	249	94	10.4	1,49
525.090.125 S	5705499117974	125	110	158	330	292	102	15.0	1,88

Accurate flow rate depending on installation.

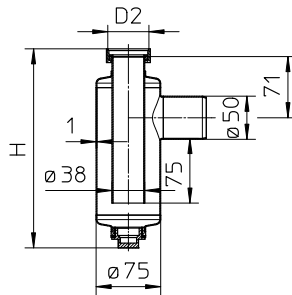
**BOTTLE WATER TRAP TYPE 505**

Type no.	EAN no.	H	D2	Kg
505.032.050 S	5705499101447	250	1¼"	0,95
505.040.050 S	5705499101454	233	1½"	0,85
505.050.050 S	5705499114058	243	2"	1,20

75 mm water seal. BSP thread.

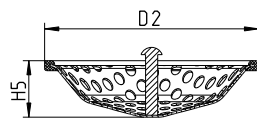
**FILTER BASKET FOR REMOVABLE TWO-PART WATER TRAP**

Type no.	EAN no.	H5	D2	Kg
502.000.000 S	5705499124101	24	106	0,07

**EXTENSION PIPE TYPE 611**

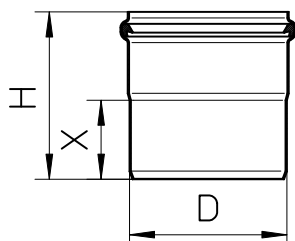

Type no.	EAN no.	D	H	X	Kg
611.300.001 S	5705499106442	110	117	55	0,40

**SEALING RING**

FOR WATER TRAP TYPE 502.052.110

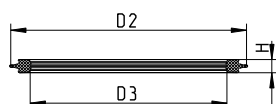

Type no.	EAN no.	H	D2	D3	Material
620.300.010	5705499106718	6	110	50	EPDM

**SEALING RING**

FOR WATER TRAP TYPE 502.050.110

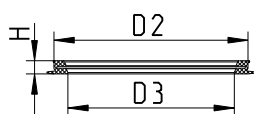

Type no.	EAN no.	H	D2	D3	Material
620.300.042	5705499127331	7	102	87	EPDM
620.300.042 N	5705499138993	7	102	87	NBR

## GROUP PENETRATION

### FOR WELDING INTO STEEL DECK

Ideal for use e.g. in service spaces near cabin modules for instance in cruise liners, allowing all sanitary units of the cabin to be connected to one fire-approved deck penetration.

The jointing unit can be pre-installed in the deck before the cabin units are fitted, thus avoiding subsequent welding.

With all penetrations for connections to and from the cabin in one place, the jointing unit contributes to making inspection and maintenance easy.

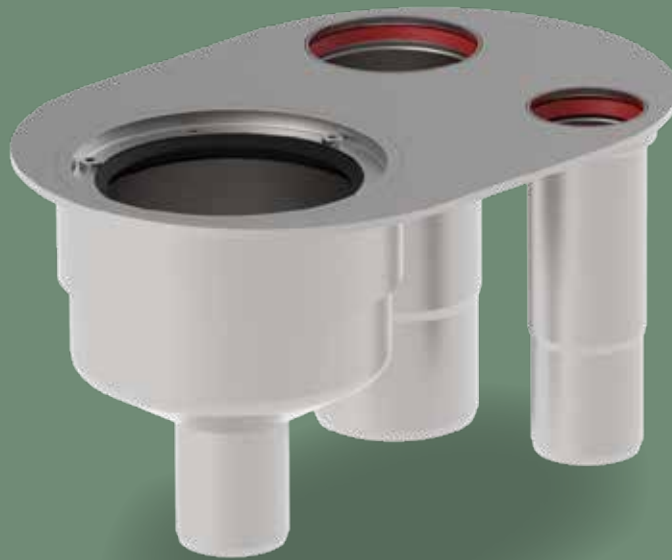

#### ■ GENERAL INFORMATION

- Fire class:** A0, A30 and A60  
**Insulation:** Detailed information regarding insulation is available in the appendix to the certificate. For products in thick-walled sleeve, please contact the supplier

#### Materials:

The jointing unit is made from stainless steel grade AISI 316L and comes with SI and CR rubber sealings for the BLÜCHER® products.

\* Fire-approved products which have been tested and approved according to IMO 2010 FTP Code Part 3.

for steel decks

**GROUP PENETRATION TYPE 490.001**

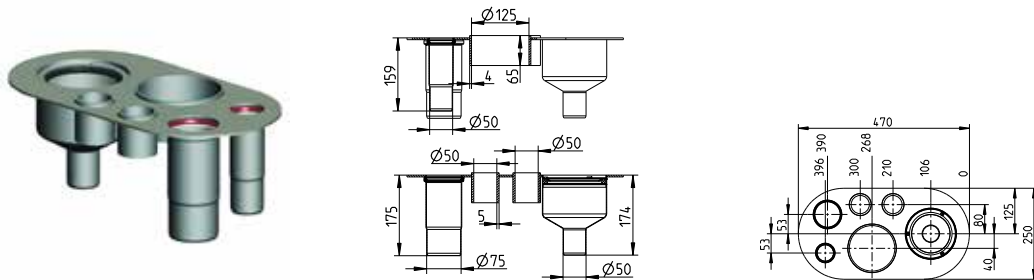

Type no.	EAN no.	EC/MED (Deck)	Kg
490.001.050 S	5705499127805	A0-A60	4,86

Other group penetrations available on request.

**INTERMEDIATE SECTION FOR GROUP PENETRATION TYPE 479**

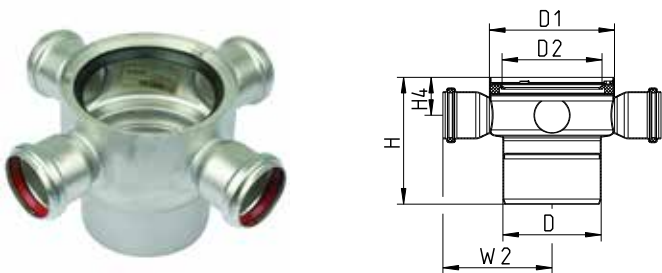

Type no.	EAN no.	D	D1	H	H4	W2	D2	Kg
479.303.110 S	5705499127812	110	140	142	43	122	113	0,92

**PLUG FOR GROUP PENETRATION TYPE 844.218**

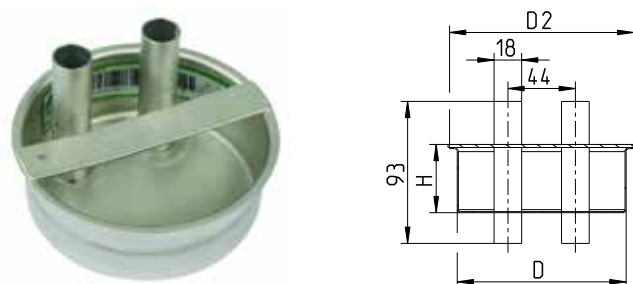

Type no.	EAN no.	D	H	D2	Kg
844.218.110 S	5705499127829	110	45	120	0,25

## BLÜCHER® CHANNELS FOR MARINE APPLICATIONS

### Well-being onboard

Clean and hygienic conditions in cabins, kitchens and sanitary facilities are important elements contributing to the efficiency and the sense of well-being onboard. Properly treated stainless steel has a unique smooth surface that guarantees maximum flow capacity and excellent hygiene. Due to its low surface roughness, bacterial growth on stainless steel is significantly less than on, for example, plastic and ordinary steel surfaces.







## Freedom of choice

BLÜCHER® Channel stainless steel drainage channels are modular deck drainage solutions for use in galleys, pantries, door openings, outside deck areas, etc. Drainage channels are available to suit all deck finishes with a range of gratings developed to suit the varying load-bearing and flow demands. Outlets are available with a removable water trap and where applicable a filter basket to prevent solids discharging into the drainage system. Customised components are available on request.

- All in stainless steel
- Modular system providing numerous possible combinations
- Multi-adjustable
- Excellent hygiene and self-cleansing properties
- Exceptional flow
- Wide range of gratings

# MARINE CHANNEL OVERVIEW

## OceanLine

- For galleys, pantries, door openings, outside deck areas, etc.
- For painted deck and covered deck
- Length: From 400 mm up to 3000 mm (straight runs)
- Width: 208 mm outside /198 mm inside
- Height: 61 mm
- 5 mm material thickness - for welding directly into deck
- Stainless steel AISI 316L (EN 1.4404) & AISI 304 (EN 1.4301)
- Flat bottom
- Different variants of gratings
- Rounded corners

## FlatLine

- For galleys, pantries, door openings, outside deck areas, bathroom, shower areas, luxury suites, etc.
- Available to suit most deck finishes
- Length: From 500 mm up to 6000 mm (straight runs)
- Width: 201 mm outside /197 mm inside
- Height: 28 mm outside – or 20 mm as a minimum
- 2 mm material thickness
- Stainless steel AISI 316L (EN 1.4404) & AISI 304 (EN 1.4301)
- Flat bottom
- Different variants of gratings
- To be used together with the BLÜCHER® Marine lower parts

## MarineLine

- For galleys, pantries, door openings, outside deck areas
- Available to suit most deck finishes
- Length: customized as per request
- Width: 150, 200, 300, 400, 500, 600, 700 and 800 mm
- Height: Minimum height 40 mm
- 2 mm material thickness  
Alternatively - can be supplied in 3-4 mm thickness for direct welding into deck

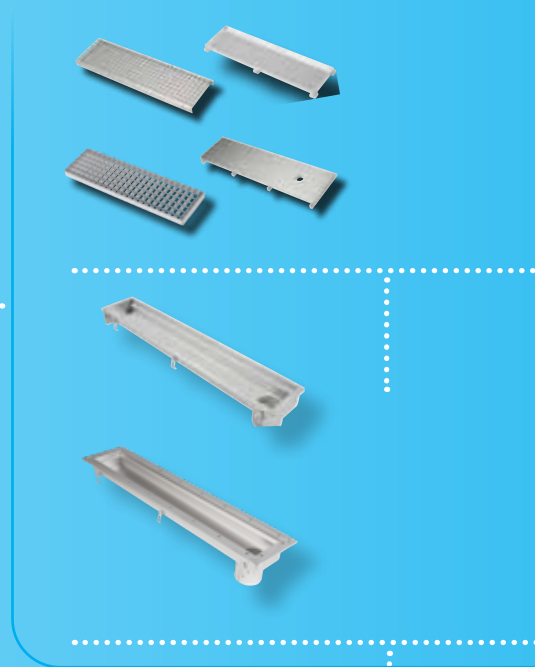
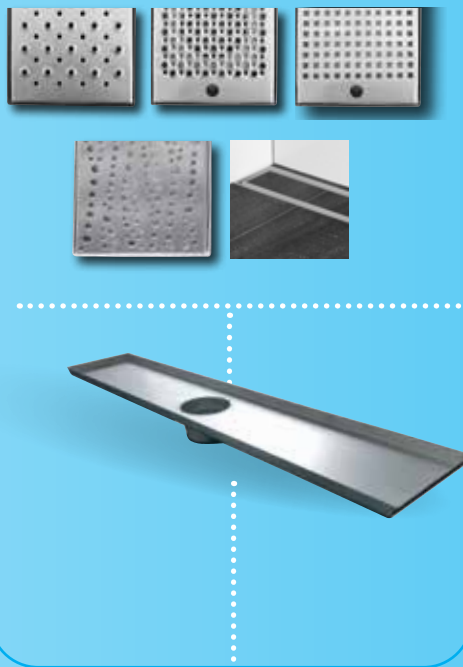
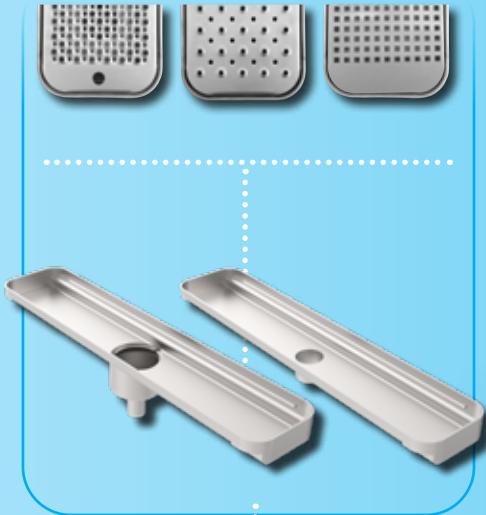

**Steel deck**







MARINE

## MultiLine

- Stainless steel AISI 316L (EN 1.4404) & AISI 304 (EN 1.4301)
- All standard gratings can be installed
- Cross/longitudinal fall for high self cleaning
- Channels in customized designs e.g. L, U and T shape
- To be used together with the BLÜCHER® Marine lower parts

- Inside door openings, bathroom, shower areas, luxury suites, etc.
- Low height
- With 2 mm frame width on all four sides
- Elegant design
- Length: standard length of 800, 900, 1000 and 1200 mm
- Width: 132 mm outside
- Height: 19 mm for type Stockholm, and 28 mm for type Tokyo
- 2 mm material thickness
- Stainless steel AISI 304/EN 1.4301
- Cross fall
- To be used together with the BLÜCHER Marine® lower parts

## WaterLine

- For bathroom, shower areas, wet cabins, luxury suites, inside door openings, etc.
- Available to suit most deck finishes
- Elegant design
- Many different design gratings
- Full flexibility
- All in stainless steel AISI 304/EN 1.4301
- Brushed finish

### For tiled floor - with or without liquid or sheet membrane

- Standard length of 300, 700, 800, 900 and 1000 mm
- Up to 2000 mm length as customized channel (Tokyo grating only 1000 mm)
- 20 mm frame width
- Adjustable frame height
- Can be installed with outlet left or right and against wall(s) or away from wall(s)

### For vinyl floor

- Standard length of 700, 800, 900 and 1000 mm (customized length not possible)

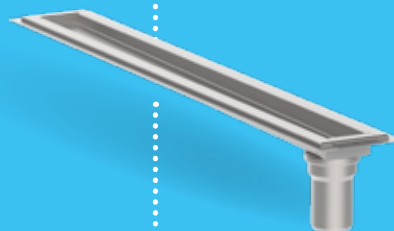
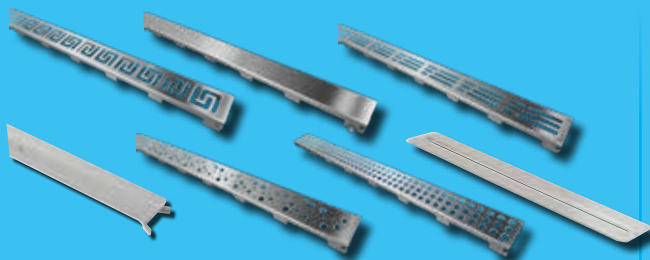
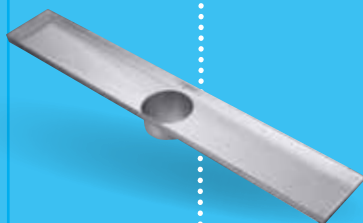
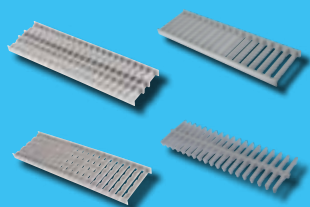

### INSTALLATION WITHOUT WELDING



470.900.050 S  
470.900.075 S  
470.900.110 S

475.900.050 S  
475.900.075 S



485.200.050 S  
485.200.075 S



480.200.050 S  
480.200.750 S  
480.200.110 S



### Aluminum deck

### Steel deck







# BLÜCHER® FlatLine

- Extra low channel



**NEW**



**FlatLine request form**  
Find it here: [www.blucher-marine.com](http://www.blucher-marine.com)

### Applications

- For galleys, pantries, door openings, outside deck areas, bathroom, shower areas, luxury suites, etc.
- Available to suit most deck finishes

### Highlights

- Minimum height of 20 mm
- With 2 mm frame width on all four sides
- Elegant design

## Gratings:

### SHOWER GRATING

(8x8 mm holes)

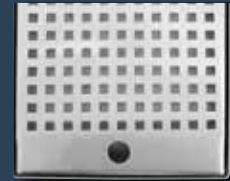

### STOCKHOLM GRATING



### TOKYO GRATING



### O2 GRATING

Non-slip grating  
(9 mm holes)



### HIGH HEEL GRATING

Non-slip grating  
(7 mm holes)



## Details:

- Length: From 500 mm up to 6000 mm (straight runs)
- Width: 201 mm outside /197 mm inside
- Height: 28 mm outside – (or 20 mm as custom made)  
2 mm material thickness
- Stainless steel AISI 316L (EN 1.4404) & AISI 304 (EN 1.4301)
- Flat bottom
- To be used together with the BLÜCHER Marine lower parts

## Outlet:

- Outlet pipe dimension is  $\varnothing 110$  mm
- Outlet placed in end or center

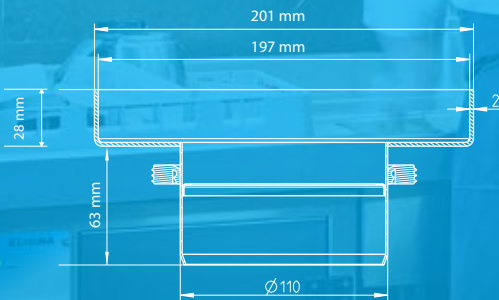

## Options:



- Water trap
- Filter basket
- Filter plate
- Anchor tangs
- Adjustable legs

**BLÜCHER**<sup>®</sup>  
A WATTS Brand



# BLÜCHER® FlatLine proposals ...

## CHANNEL FLATLINE FOR TILED OR EPOXY FLOORING - CENTER OUTLET

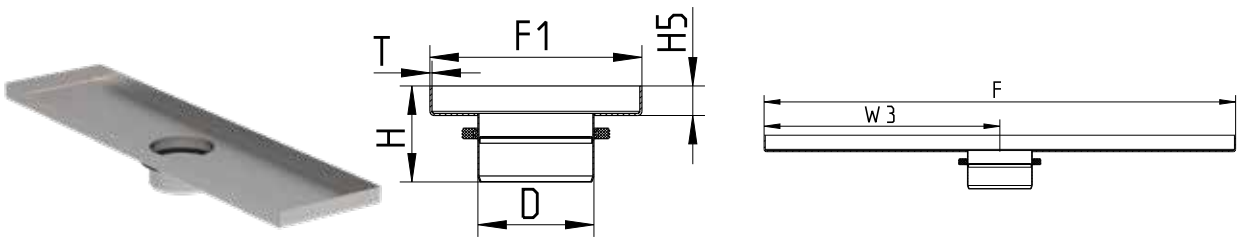

TYPE NO.	D	F	F1	H	H5	T	W3	MATERIAL
699-19106-01	Ø110	800	201	91	28	2	400	AISI 304
699-19106-02	Ø110	1000	201	91	28	2	500	AISI 304
699-19106-03	Ø110	1200	201	91	28	2	600	AISI 304

## CHANNEL FLATLINE FOR TILED OR EPOXY FLOORING - END OUTLET

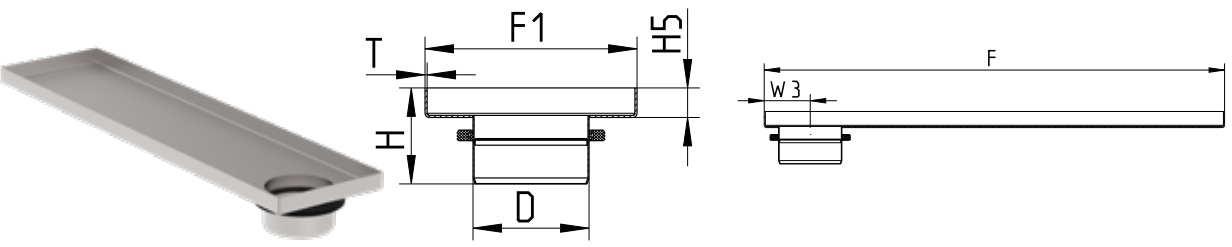

TYPE NO.	D	F	F1	H	H5	T	W3	MATERIAL
699-19106-04	Ø110	800	201	91	28	2	80	AISI 304
699-19106-05	Ø110	1000	201	91	28	2	80	AISI 304
699-19106-06	Ø110	1200	201	91	28	2	80	AISI 304

## GRATING - TYPE SHOWER

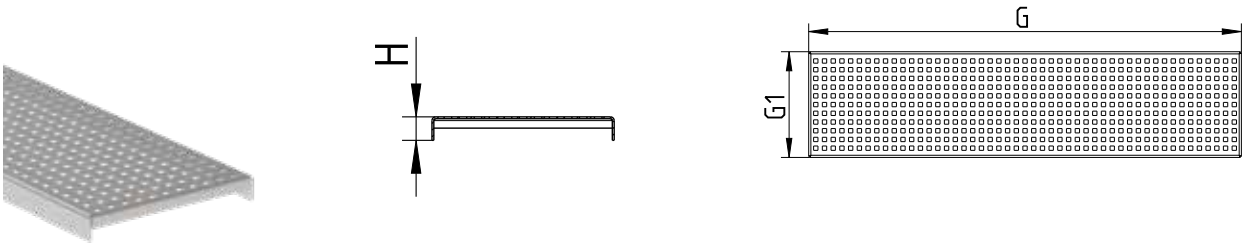

TYPE NO.	G	G1	H	MATERIAL	EN1253 (KG)	NON-SLIP
697.019.200.794	794	194	25	AISI 304	K3 (400)	R10
697.019.200.994	994	194	25	AISI 304	K3 (400)	R10
697.019.200.596 - NOTE! 2 pieces required	596	194	25	AISI 304	K3 (400)	R10

... you can also customize your own channel by using our FlatLine request form



**FlatLine request form**  
Find it here: [www.blucher-marine.com](http://www.blucher-marine.com)

All dimensions in mm – If Stainless Steel grade AISI 316L / EN 1.4404 is required specify type no. with suffix S



# BLÜCHER® FlatLine proposals ...

## GRATING - TYPE TOKYO

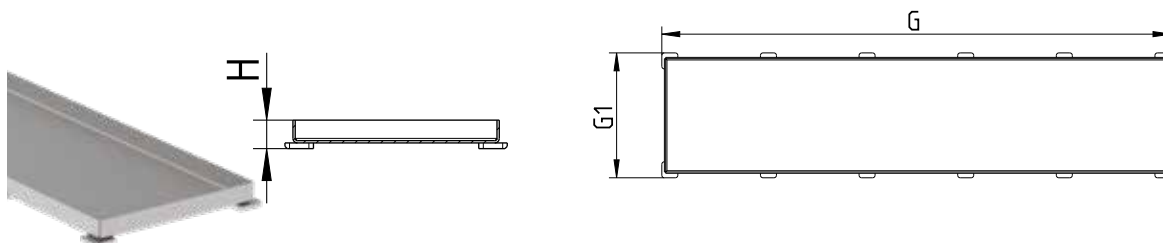

TYPE NO.	G	G1	H	MATERIAL	EN1253 (kg)	NON-SLIP
697.020.200.795	795	195	25	AISI 304	L15 (1800)	R10
697.020.200.995	995	195	25	AISI 304	L15 (1800)	R10
697.020.200.1195	1195	195	25	AISI 304	L15 (1800)	R10

## GRATING - TYPE STOCKHOLM

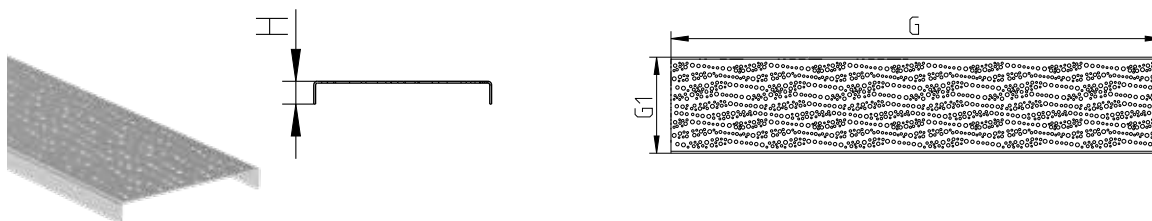

TYPE NO.	G	G1	H	MATERIAL	EN1253 (kg)	NON-SLIP
697.055.200.794	794	194	25	AISI 304	K3 (300)	R10
697.055.200.994	994	194	25	AISI 304	K3 (300)	R10
697.055.200.1194	1194	194	25	AISI 304	K3 (300)	R10

## GRATING - TYPE O2

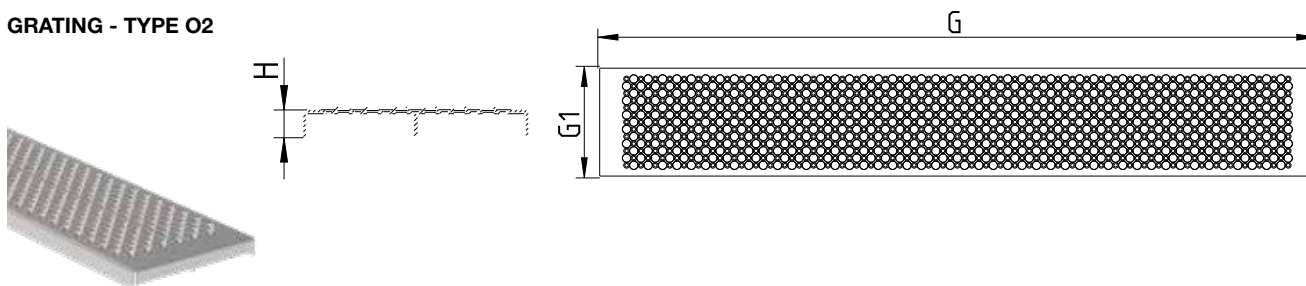

TYPE NO.	G	G1	H	MATERIAL	EN1253 (kg)	NON-SLIP
697.035.200.794	794	194	24	AISI 304	L15 (1200)	R13
697.035.200.994	994	194	24	AISI 304	L15 (1200)	R13
697.035.200.1194	1194	194	24	AISI 304	L15 (1200)	R13

All dimensions in mm – If Stainless Steel grade AISI 316L / EN 1.4404 is required specify type no. with suffix S

# BLÜCHER® FlatLine proposals ...

## GRATING - TYPE HIGH HEEL

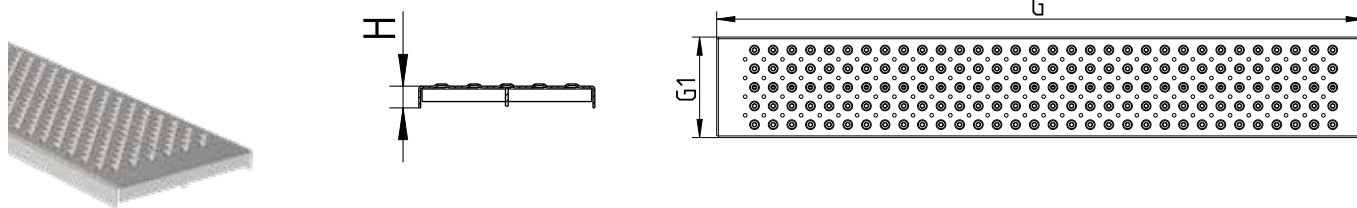

TYPE NO.	G	G1	H	MATERIAL	EN1253 (KG)	NON-SLIP
697.045.200.794	794	194	24	AISI 304	L15 (1200)	R11
697.045.200.994	994	194	24	AISI 304	L15 (1200)	R11
697.045.200.1194	1194	194	24	AISI 304	L15 (1200)	R11

All dimensions in mm – If Stainless Steel grade AISI 316L / EN 1.4404 is required specify type no. with suffix S

# BLÜCHER® FlatLine

**Material grade:** AISI 316L  
AISI 304

**Standard Length:** 800 mm 1000 mm 1200 mm  
*(If a customized length (min. 500 mm - max. 6.000 mm) is requested, please contact Customer Center)*

**Width:** 201 mm outside (197 mm inside)

**Further details:** Channel matr. thickness 2 mm., Channel height: 28 mm outside – (or 20 mm as custom made)

Click for more info in the Marine Channel brochure



**Keep in mind:**

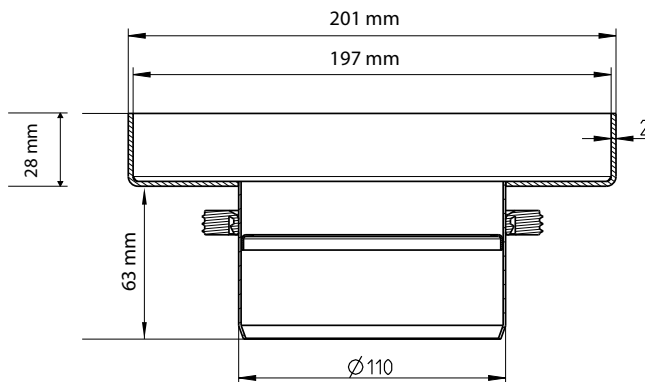

- No slope in the channel
- No flanged connections

**Channel profile & dimensions:**



**Outlet size:** Ø110 mm

**Outlet position:** In center  
In end

- Accessories:**
- Water trap (removable) 
  - OR**
  - P-water trap 
  - OR**
  - Filter basket 

**AND filter plate** 

FlatLine channel to be used together with a BLÜCHER® Marine lower part



**Grating Type:** **Stockholm Grating**  
Max. hole size 8 mm



**Tokyo Grating**  
5 mm gap/opening



**Shower Grating**  
8 x 8 mm holes

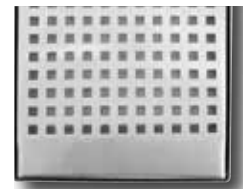

**O2 Grating**  
Non-slip / 9 mm holes

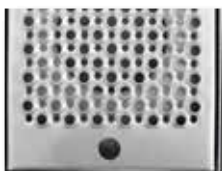

**High Heel Grating**  
Non-slip / 7 mm holes

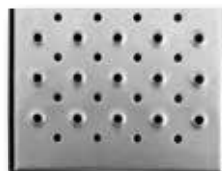

Finger hole

# BLÜCHER® OceanLine

- New channel design



**NEW**



### Applications

- For galleys, pantries, door openings, outside deck areas, etc.
- For painted deck and covered deck

### Highlights

- 5 mm material thickness for welding directly into deck
- Different variants of gratings
- Rounded corners



**OceanLine request form**  
Find it here: [www.blucher-marine.com](http://www.blucher-marine.com)



## Details:

- Length: From 400 mm up to 3000 mm (straight runs)
- Width: 208 mm outside /198 mm inside
- Height: 61 mm
- 5 mm material thickness
- Stainless steel AISI 316L (EN 1.4404) & AISI 304 (EN 1.4301)
- Flat bottom



## Channel outlet types:

### TYPE 1

#### – with lower part (outlet box)

- Vertical or horizontal outlet
- Outlet pipe dimensions:
  - Ø50, 75, 110 mm or
  - Ø60,3, 76,1, 88,9 mm (thickwalled pipe for welding)
- Outlet placed in end or center

#### Options:



### TYPE 2

#### – with outlet pipe

- Vertical outlet
- Outlet pipe dimensions:
  - Ø50, 75, 110 mm or
  - Ø60,3, 76,1, 88,9 mm (thickwalled pipe for welding)
- Outlet placed in end or center

#### Options:



only with Ø110 mm

## Gratings:

### O2 GRATING

Non-slip grating (9 mm holes)



### HIGH HEEL GRATING

Non-slip grating (7 mm holes)



### SHOWER GRATING

(8x8 mm holes)



### TYPE 1

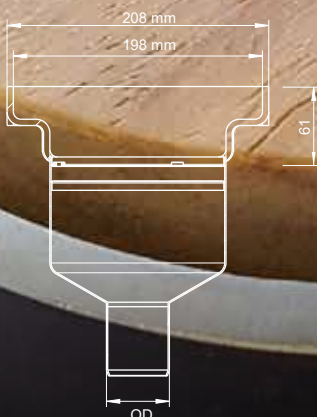

### TYPE 2

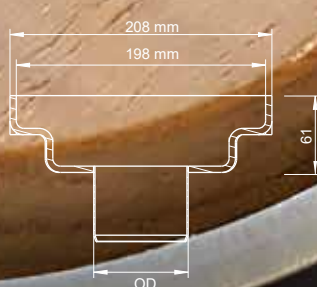

- Water trap
- P-trap
- Filter basket
- Filter plate

**BLÜCHER**<sup>®</sup>  
A WATTS Brand

# BLÜCHER® OceanLine proposals ...

## BLÜCHER OCEANLINE - TYPE 1

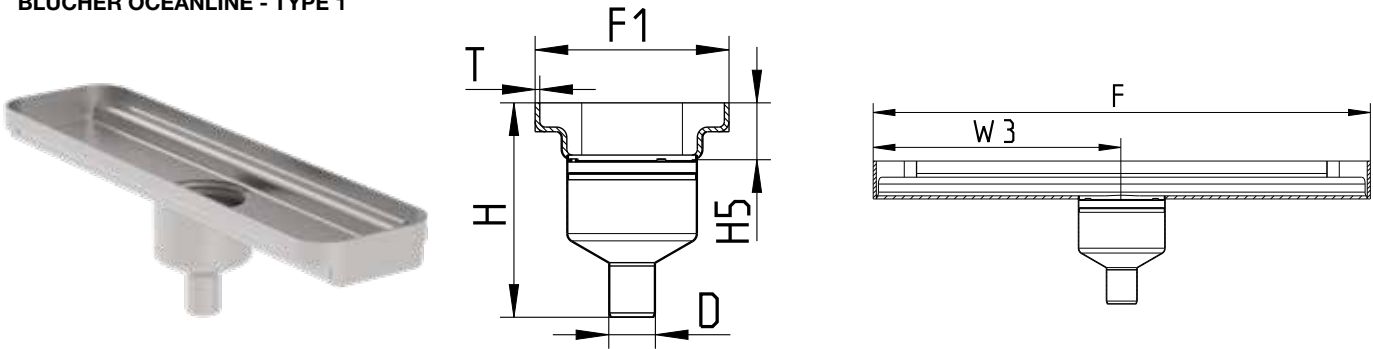

TYPE NO.	D	F	F1	H	H5	T	W3	MATERIAL
699-19102-01	Ø50	800	208	230	61	5	400	AISI 304
699-19102-02	Ø50	1000	208	230	61	5	500	AISI 304
699-19102-03	Ø50	1200	208	230	61	5	600	AISI 304
699-19102-04	Ø75	800	208	228	61	5	400	AISI 304
699-19102-05	Ø75	1000	208	228	61	5	500	AISI 304
699-19102-06	Ø75	1200	208	228	61	5	600	AISI 304
699-19102-07	Ø110	800	208	202	61	5	400	AISI 304
699-19102-08	Ø110	1000	208	202	61	5	500	AISI 304
699-19102-09	Ø110	1200	208	202	61	5	600	AISI 304

## BLÜCHER OCEANLINE - TYPE 2

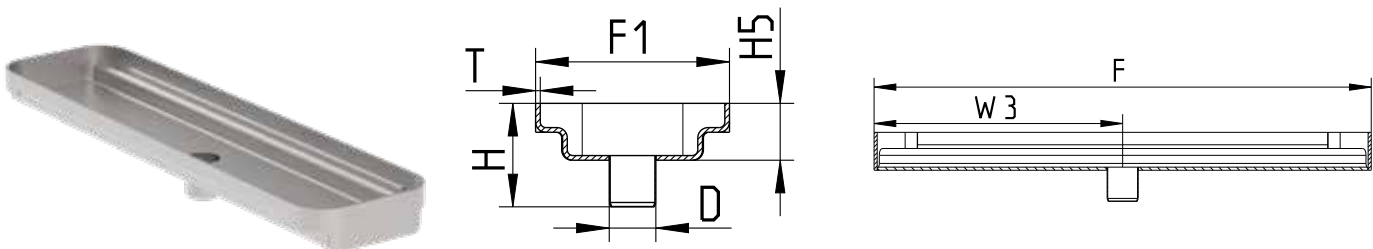

TYPE NO.	D	F	F1	H	H5	T	W3	MATERIAL
699-19102-10	ø50	800	208	111	61	5	400	AISI 304
699-19102-11	ø50	1000	208	111	61	5	500	AISI 304
699-19102-12	ø50	1200	208	111	61	5	600	AISI 304
699-19102-13	ø75	800	208	116	61	5	400	AISI 304
699-19102-14	ø75	1000	208	116	61	5	500	AISI 304
699-19102-15	ø75	1200	208	116	61	5	600	AISI 304
699-19102-16	ø110	800	208	121	61	5	400	AISI 304
699-19102-17	ø110	1000	208	121	61	5	500	AISI 304
699-19102-18	ø110	1200	208	121	61	5	600	AISI 304

... you can also customize your own channel by using our OceanLine request form



**OceanLine request form**  
Find it here: [www.blucher-marine.com](http://www.blucher-marine.com)

All dimensions in mm – If Stainless Steel grade AISI 316L / EN 1.4404 is required specify type no. with suffix S

# BLÜCHER® OceanLine proposals ...

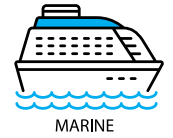

## GRATING - TYPE O2

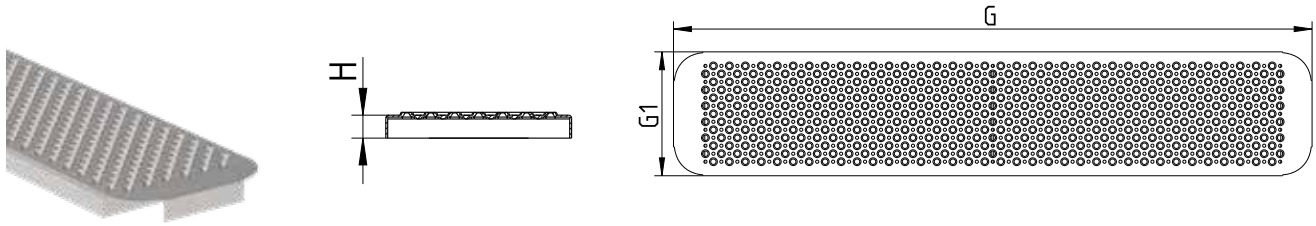

TYPE NO.	G	G1	H	MATERIAL	EN1253 (KG)	NON-SLIP
697.037.200.788	788	194	24	AISI 304	L15 (1400)	R13
697.037.200.988	988	194	24	AISI 304	L15 (1400)	R13
697.037.200.1188	1188	194	24	AISI 304	L15 (1400)	R13

## GRATING - TYPE HIGH HEEL

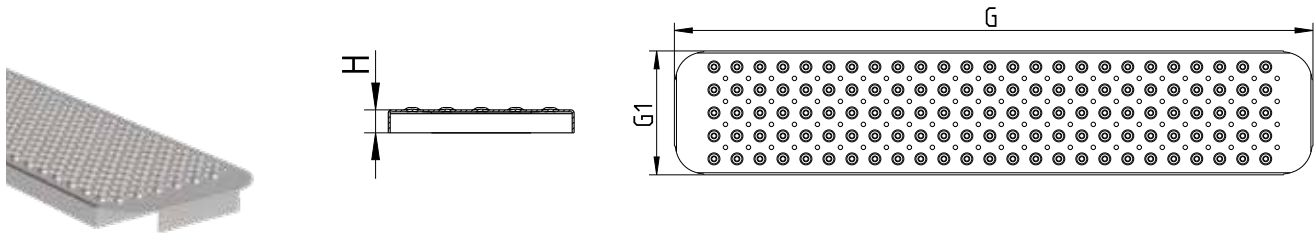

TYPE NO.	G	G1	H	MATERIAL	EN1253 (KG)	NON-SLIP
697.047.200.788	788	194	24	AISI 304	L15 (1400)	R11
697.047.200.988	988	194	24	AISI 304	L15 (1400)	R11
697.047.200.1188	1188	194	24	AISI 304	L15 (1400)	R11

## GRATING - TYPE SHOWER

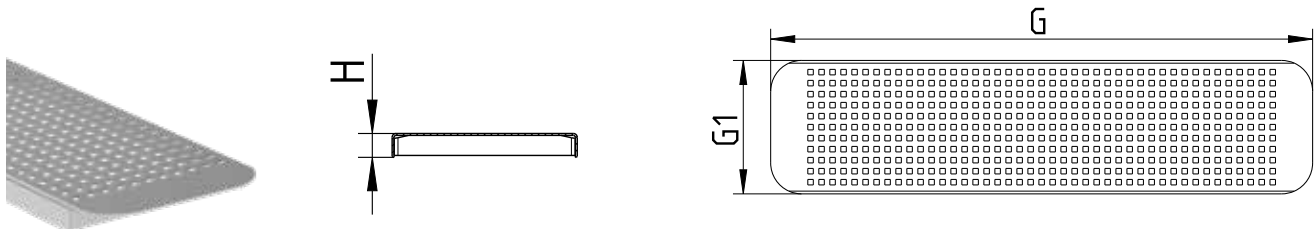

TYPE NO.	G	G1	H	MATERIAL	EN1253 (KG)	NON-SLIP
697.017.200.788	788	194	25	AISI 304	K3 (400)	R10
697.017.200.988	988	194	25	AISI 304	K3 (400)	R10
697.017.200.1188	1188	194	25	AISI 304	K3 (400)	R10

All dimensions in mm – If Stainless Steel grade AISI 316L / EN 1.4404 is required specify type no. with suffix S

All dimensions in mm – If Stainless Steel grade AISI 316L / EN 1.4404 is required specify type no. with suffix S



## BLÜCHER® OceanLine

**Material grade:** AISI 316L  
AISI 304

**Standard Length:** 800 mm 1000 mm 1200 mm  
*(If a customized length (min. 400 mm - max. 3.000 mm) is requested, please contact Customer Center)*

**Width:** 208 mm outside (198 mm inside) - **NOTE the width is fixed**

**Further details:** Channel matr. thickness 5 mm., Channel height excl. outlet box or pipe = 61 mm

Click for more info in the Marine Channel brochure



**Keep in mind:**

- No slope in the channel
- No flanged connections

**TYPE 1:**

With outlet box for water trap or filter basket

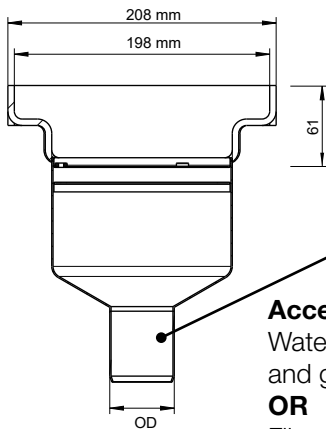

**Outlet position:**

In center

In end

**Outlet box type:**

Vertical outlet

Horizontal outlet

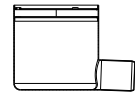
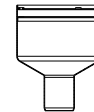

**Outlet size:**

**BLÜCHER dimension**  
OD50 mm  
OD75 mm  
OD110 mm

**Thick walled pipe for welding**  
OD60,3 mm  
OD76,1 mm  
OD88,9 mm

**Accessories:**

Water trap and support ring and grating (474.300.110 S)



**OR**

Filter basket and support ring and grating (474.300.110 S)



**OR** P-water trap



**AND** Filterplate



**TYPE 2:**

With outlet pipe

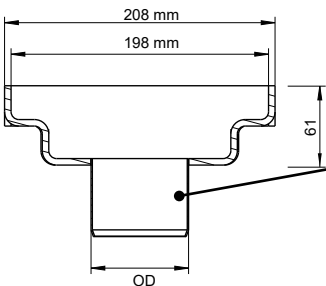

**Outlet position:**

In center

In end

**Outlet size:**

**BLÜCHER dimension**  
OD50 mm  
OD75 mm  
OD110 mm

**Thick walled pipe for welding**  
OD60,3 mm  
OD76,1 mm  
OD88,9 mm

**Accessories:**

**AND** filter plate\*



**OR** Filter basket\*



Water trap\* (removable)



**OR** P-water trap



\* Only with Ø110 mm outlet pipe (type H7-0126-001)

**Grating Type:**

**O2 Grating**

Non-slip / 9 mm holes



**High Heel Grating**

Non-slip / 7 mm holes



**Shower Grating**

8 x 8 mm holes



Finger hole



# BLÜCHER® WaterLine

- design shower channel



### Applications

- For bathroom, shower areas, wet cabins, luxury suites, inside door openings, etc.
- Available to suit most deck finishes

### Highlights

- Elegant design
- Many different design gratings
- Full flexibility



**WaterLine request form**  
Find it here: [www.blucher-marine.com](http://www.blucher-marine.com)

## Details:

- **For tiled floor - with or without liquid or sheet membrane**
  - Standard length of 300, 700, 800, 900 and 1000 mm
  - Up to 2000 mm length as customized channel (Tokyo grating only 1000 mm)
  - 20 mm frame width
  - Adjustable frame height
  - Can be installed with outlet left or right and against wall(s) or away from wall(s)
- **For vinyl floor**
  - Standard length of 700, 800, 900 and 1000 mm (customized length not possible)
- All in stainless steel AISI 304/EN 1.4301
- Brushed finish

## Gratings:

**GRATING LINE ATHENS**

**GRATING LINE COPENHAGEN**

**GRATING LINE DETROIT**

**GRATING LINE TOKYO**

**GRATING LINE OSLO**

**GRATING LINE VIENNA**

**GRATING LINE COPENHAGEN VINYL**

## Options:

- Range of different water traps
- Different design gratings

## Installation examples

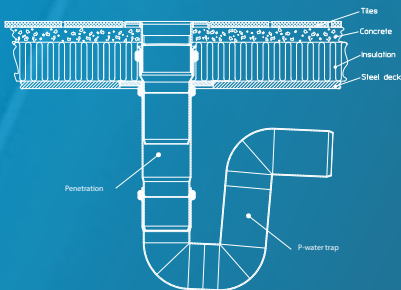

### Tiled floor - P-water trap

BLÜCHER penetration type 868.105.050FS

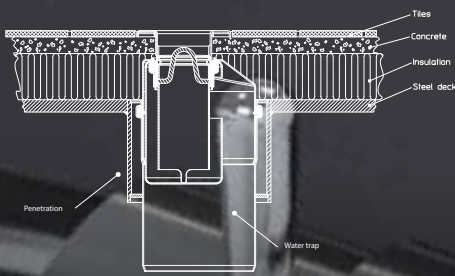

### Tiled floor - Built in water trap

BLÜCHER penetration type 870.000.110FS

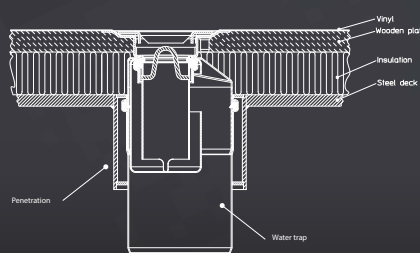

### Vinyl floor - Built in water trap

BLÜCHER penetration type 870.000.110FS



# BLÜCHER® WaterLine proposals ...

## CHANNEL WATERLINE TYPE 178 FOR TILED OR EPOXY FLOORING

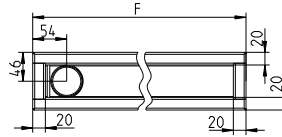
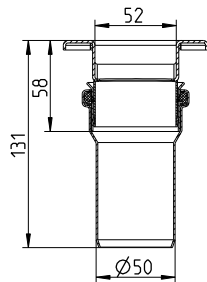

TYPE NO.	EAN NO.	NAME	F	MATERIAL
178.030.056.20	5705499138108	50x300	274	AISI 304
178.070.056.20	5705499138429	50x700	674	AISI 304
178.080.056.20	5705499138115	50x800	774	AISI 304
178.090.056.20	5705499138122	50x900	874	AISI 304
178.100.056.20	5705499138139	50x1000	974	AISI 304

## SHOWER CHANNEL WATERLINE TYPE 275 FOR VINYL FLOORING

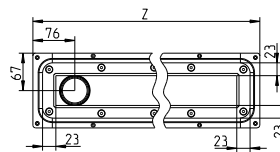
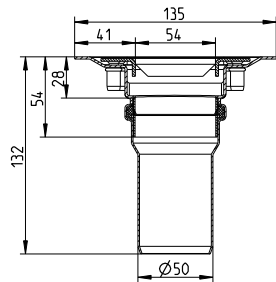

TYPE NO.	EAN NO.	NAME	Z	MATERIAL
275.070.056.20	5705499122527	50x700	717	AISI 304
275.080.056.20	5705499122534	50x800	817	AISI 304
275.090.056.20	5705499122541	50x900	917	AISI 304
275.100.056.20	5705499122558	50x1000	1017	AISI 304

## WATER TRAP FOR WATERLINE, VERTICAL MODEL TO BE BUILT IN - CANNOT BE RETRO-FITTED

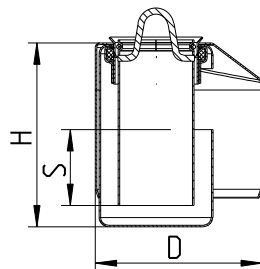

TYPE NO.	EAN NO.	D	H	S	MAX FLOW (L/S)
510.004.110	5705499138535	110	121	50	0.9

Accurate flwing on type of grating.

... you can also customize your own channel  
by using our WaterLine request form



WaterLine request form

Find it here: [www.blucher-marine.com](http://www.blucher-marine.com)



# BLÜCHER® WaterLine proposals ...

## GRATING LINE ATHENS

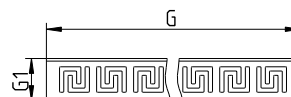
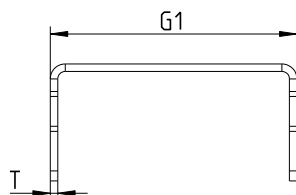

TYPE NO.	EAN NO.	G	G1	T	MAX FLOW (L/S)	MATERIAL
697.005.030	5705499122794	232	50	1.5	0.7	AISI 304
697.005.070	5705499122800	632	50	1.5	0.9	AISI 304
697.005.080	5705499122817	732	50	1.5	0.9	AISI 304
697.005.090	5705499122824	832	50	1.5	0.9	AISI 304
697.005.100	5705499122831	932	50	1.5	0.9	AISI 304

Accurate flow rate depending on type of water trap.

## GRATING LINE COPENHAGEN

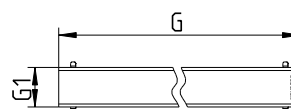
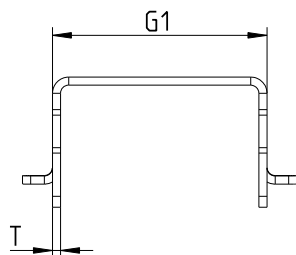

TYPE NO.	EAN NO.	G	G1	T	MAX FLOW (L/S)	MATERIAL
697.004.030	5705499119251	232	40	1.5	0.9	AISI 304
697.004.070	5705499119268	632	40	1.5	1.1	AISI 304
697.004.080	5705499119275	732	40	1.5	1.1	AISI 304
697.004.090	5705499119282	832	40	1.5	1.1	AISI 304
697.004.100	5705499119299	932	40	1.5	1.1	AISI 304

Accurate flow rate depending on type of water trap.

## RATING LINE DETROIT

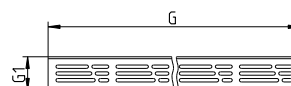
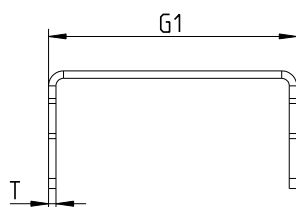

TYPE NO.	EAN NO.	G	G1	T	MAX FLOW (L/S)	MATERIAL
697.006.030	5705499122862	232	50	1.5	0.6	AISI 304
697.006.070	5705499122879	632	50	1.5	0.7	AISI 304
697.006.080	5705499122886	732	50	1.5	0.7	AISI 304
697.006.090	5705499122893	832	50	1.5	0.7	AISI 304
697.006.100	5705499122909	932	50	1.5	0.7	AISI 304

# BLÜCHER® WaterLine proposals ...

## GRATING LINE OSLO

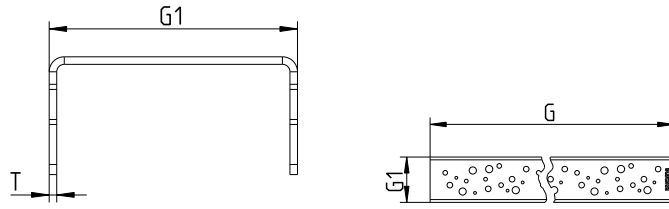

TYPE NO.	EAN NO.	G	G1	T	MAX FLOW (L/S)	MATERIAL
697.008.030	5705499122725	232	50	1.5	0.4	AISI 304
697.008.070	5705499122732	632	50	1.5	0.5	AISI 304
697.008.080	5705499122749	732	50	1.5	0.5	AISI 304
697.008.090	5705499122756	832	50	1.5	0.5	AISI 304
697.008.100	5705499122763	932	50	1.5	0.5	AISI 304

Accurate flow rate depending on type of water trap.

## GRATING LINE VIENNA

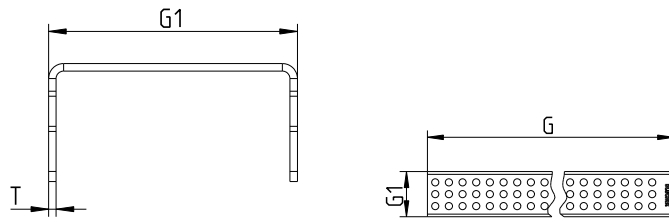

TYPE NO.	EAN NO.	G	G1	T	MAX FLOW (L/S)	MATERIAL
697.003.030	5705499119206	232	50	1.5	0.7	AISI 304
697.003.070	5705499119213	632	50	1.5	0.9	AISI 304
697.003.080	5705499119220	732	50	1.5	0.9	AISI 304
697.003.090	5705499119237	832	50	1.5	0.9	AISI 304
697.003.100	5705499119244	932	50	1.5	0.9	AISI 304

Accurate flow rate depending on type of water trap.

## GRATING LINE TOKYO

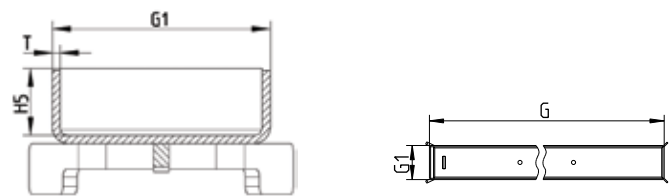

TYPE NO.	EAN NO.	G	G1	HS	T	MAX FLOW (L/S)	MATERIAL
697.009.030	5705499126983	224	42	13	1.5	0.8	AISI 304
697.009.070	5705499126990	624	42	13	1.5	0.8	AISI 304
697.009.080	5705499127003	724	42	13	1.5	0.8	AISI 304
697.009.090	5705499127010	824	42	13	1.5	0.8	AISI 304
697.009.100	5705499127027	924	42	13	1,5	0.8	AISI 304

Accurate flow rate depending on type of water trap.



# BLÜCHER® WaterLine proposals ...

GRATING LINE COPENHAGEN VINYL  
FOR WATERLINE SHOWER CHANNEL FOR VINYL FLOORS

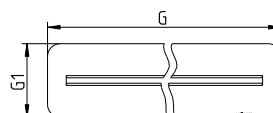
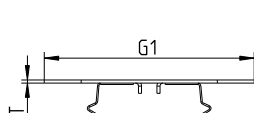

TYPE NO.	EAN NO.	G	G1	T	MAX FLOW (L/S)	MATERIAL
697.104.070	5705499122565	685	103	1.5	0.6	AISI 304
697.104.080	5705499122572	785	103	1.5	0.6	AISI 304
697.104.090	5705499122589	885	103	1.5	0.6	AISI 304
697.104.100	5705499122596	985	103	1.5	0.6	AISI 304

Accurate flow rate depending on type of water trap.

... you can also customize your own channel  
by using our WaterLine request form



**WaterLine request form**

Find it here: [www.blucher-marine.com](http://www.blucher-marine.com)



# BLÜCHER® WaterLine

Click for more  
info in the  
Marine Channel  
brochure



**FOR TILED FLOOR** - with or without liquid or sheet membrane

**Standard Length:** 300 mm 700 mm 800 mm  
900 mm 1000 mm

*(Up to 2000 mm length as customized channel -  
Tokyo grating up to 1000 mm)*



**FOR VINYL FLOOR**

**Standard Length:** 700 mm 800 mm 900 mm 1000 mm

*(customized length not possible)*

**Material thickness:** 1,5 mm material thickness

**Outlet position:** In the end. Can be installed with outlet left or right  
and against wall(s) or away from wall(s).

**Material grade:** AISI 304

**Further details/possibilities:**

- Longitudinal fall
- Brushed finish
- Range of different water traps



**Grating Type:**

**Grating Line  
ATHENS**



**Grating Line  
COPENHAGEN**



**Grating Line  
DETROIT**



**Grating Line  
TOKYO**



**Grating Line  
OSLO**



**Grating Line  
VIENNA**



**Grating Line  
COPENHAGEN VINYL**





# BLÜCHER® MarineLine

- Design your own solution



### Applications

- For galleys, pantries, door openings, outside deck areas
- Available to suit all deck finishes

### Highlights

- Standard or customised solutions
- Hygienic design
- Gratings for any purpose and load class



**MarineLine request form**  
Find it here: [www.blucher-marine.com](http://www.blucher-marine.com)



## Details:

- Length: customized as per request
- Width: 150, 200, 300, 400, 500, 600, 700 and 800 mm
- Height: Minimum height 40 mm  
2 mm material thickness  
*(Can alternatively be supplied as customized channels in 3-4 mm thickness for direct welding on deck. Please contact our Customer Center for further information).*
- Stainless steel AISI 316L (EN 1.4404) & AISI 304 (EN 1.4301)
- All standard gratings can be installed
- Cross/Longitudinal fall for high self cleaning
- Channels in customized designs e.g. L, U and T shape
- To be used together with the BLÜCHER Marine lower parts

## Gratings:

**SHOWER GRATING**

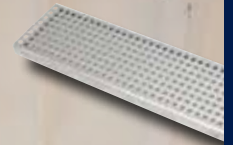

**TILED/EPOXY GRATING**



**LADDER GRATING**



**LADDER GRATING NON-TILT**

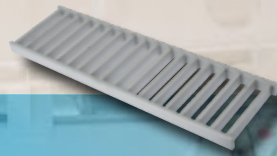

## Outlet:

- Outlet pipe dimension is Ø110 mm
- Outlet placed in end or center

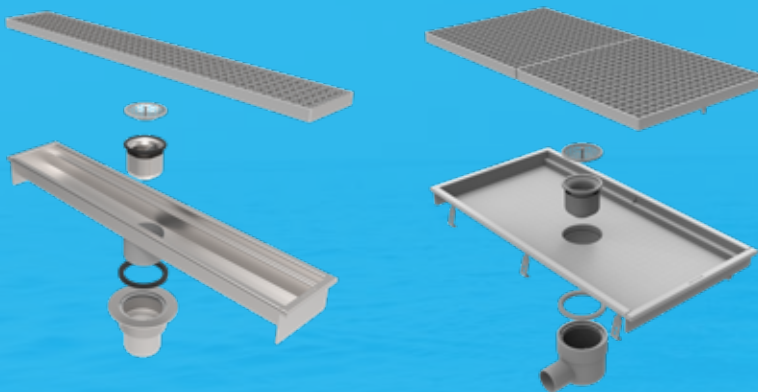

## Options:



**MESH GRATING**

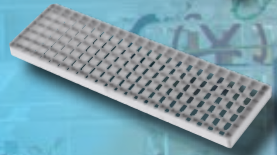

**SLOT GRATING**



**LADDER GRATING fully welded**

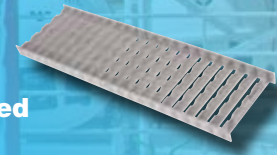

**HygienicPro GRATING**

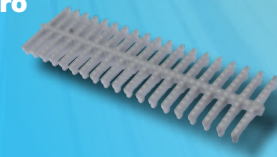

## Be inspired ...

**Type 670 Channel for concrete, tiled and resin floors**  
Width: 150, 200, 300 or 400 mm  
Length: 1 - 6 metres



**Type 674 Channel with 50 mm liquid membrane flange for concrete, tiled and resin floors**  
Width: 150, 200, 300 or 400 mm  
Length: 0,9 - 6 metres



**Type 671 Channel with outlet box for concrete, tiled and resin floors**  
Width: 150 mm  
Length: 1 - 6 metres



**Type 677 8 mm slot channel with 50 mm liquid membrane flange for concrete, tiled and resin floors**  
Width: 8 mm  
Length: 1-3 metres



**Type 673 20 mm slot channel with outlet box for concrete, tiled and resin floors**  
Width: 20 mm  
Length: 1 - 12 metres  
Grating: For outlet box only



**Type 672 Channel for vinyl floors**  
Width: 150, 200, 300 or 400 mm  
Length: 0,9 - 6 metres



# BLÜCHER® MarineLine proposals ...

## CHANNEL TYPE 670 FOR TILES AND EPOXY FLOORING - END OUTLET

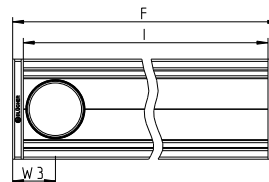
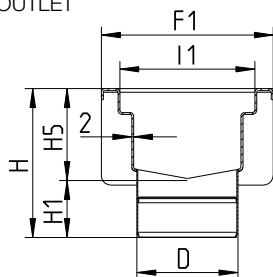

TYPE NO.	EAN NO.	NAME	D	F	F1	H	H1	H5	I	I1	W3
670CH010-00BA	5705499125726	150x1000	110	1040	187	152	62	90	1000	147	80
670CH015-00BA	5705499125733	150x1500	110	1540	187	152	62	90	1500	147	80
670CH020-00BA	5705499125740	150x2000	110	2040	187	152	62	90	2000	147	80
670CH030-00BA	5705499125757	150x3000	110	3056	187	152	62	90	3016	147	80
670DH010-00BA	5705499129526	200x1000	110	1040	237	152	62	90	1000	197	80
670DH015-00BA	5705499129540	200x1500	110	1540	237	152	62	90	1500	197	80
670DH020-00BA	5705499129564	200x2000	110	2040	237	152	62	90	2000	197	80
670DH030-00BA	5705499129588	200x3000	110	3056	237	152	62	90	3016	197	80

 Sealing ring IG.054 CR for marine lower parts to be ordered separately.

## CHANNEL TYPE 670 FOR TILES AND EPOXY FLOORING - CENTER OUTLET

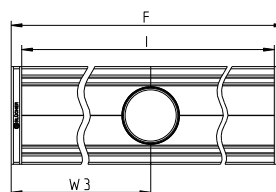
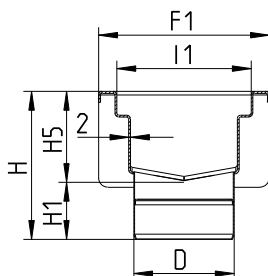

TYPE NO.	EAN NO.	NAME	D	F	F1	H	H1	H5	I	I1	W3
670CH010-05BA	5705499129427	150x1000	110	1040	187	152	62	90	1000	147	520
670CH015-08BA	5705499129434	150x1500	110	1540	187	152	62	90	1500	147	770
670CH020-10BA	5705499129441	150x2000	110	2040	187	152	62	90	2000	147	1020
670CH030-15BA	5705499129458	150x3000	110	3056	187	152	62	90	3016	147	1528
670DH010-05BA	5705499129533	200x1000	110	1040	237	152	62	90	1000	197	520
670DH015-08BA	5705499129557	200x1500	110	1540	237	152	62	90	1500	197	770
670DH020-10BA	5705499129571	200x2000	110	2040	237	152	62	90	2000	197	1020
670DH030-15BA	5705499129595	200x3000	110	3056	237	152	62	90	3016	197	1528

 Sealing ring IG.054 CR for marine lower parts to be ordered separately.

**... you can also customize your own channel by using our MarineLine request form**



**MarineLine request form**  
Find it here: [www.blucher-marine.com](http://www.blucher-marine.com)

All dimensions in mm – If Stainless Steel grade AISI 316L / EN 1.4404 is required specify type no. with suffix S



# BLÜCHER® MarineLine proposals ...

## CHANNEL TYPE 672 FOR VINYL FLOORING - END OUTLET

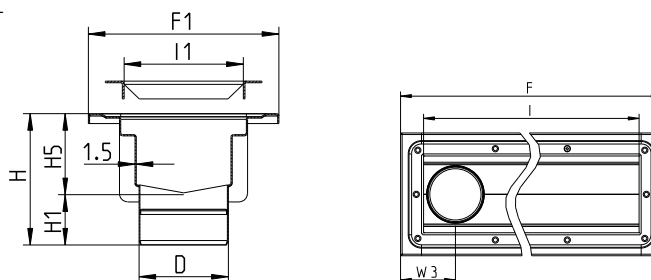

TYPE NO.	EAN NO.	NAME	D	F	F1	H	H1	H5	I	I1	W3
672CH010-00BA	5705499124798	150x1000	110	1088	235	152	62	90	1000	147	105
672CH015-00BA	5705499124804	150x1500	110	1588	235	152	62	90	1500	147	105
672CH020-00BA	5705499124811	150x2000	110	2088	235	152	62	90	2000	147	105
672CH030-00BA	5705499124828	150x3000	110	3104	235	152	62	90	3016	147	105
672DH010-00BA	5705499130249	200x1000	110	1088	285	152	62	90	1000	197	105
672DH015-00BA	5705499130263	200x1500	110	1588	285	152	62	90	1500	197	105
672DH020-00BA	5705499130287	200x2000	110	2088	285	152	62	90	2000	197	105
672DH030-00BA	5705499130300	200x3000	110	3104	285	152	62	90	3016	197	105

Sealing ring IG.054 CR for marine lower parts to be ordred seperately.

## CHANNEL TYPE 672 FOR VINYL FLOORING - CENTER OUTLET

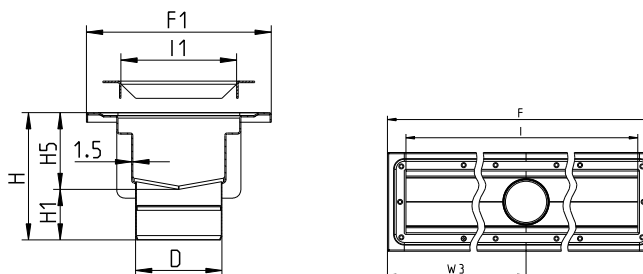

TYPE NO.	EAN NO.	NAME	D	F	F1	H	H1	H5	I	I1	W3
672CH010-05BA	5705499130140	150x1000	110	1088	235	152	62	90	1000	147	544
672CH015-08BA	5705499130157	150x1500	110	1588	235	152	62	90	1500	147	794
672CH020-10BA	5705499130164	150x2000	110	2088	235	152	62	90	2000	147	1044
672CH030-15BA	5705499130171	150x3000	110	3104	235	152	62	90	3016	147	1552
672DH010-05BA	5705499130256	200x1000	110	1088	285	152	62	90	1000	197	544
672DH015-08BA	5705499130270	200x1500	110	1588	285	152	62	90	1500	197	794
672DH020-10BA	5705499130294	200x2000	110	2088	285	152	62	90	2000	197	1044
672DH030-15BA	5705499130317	200x3000	110	3104	285	152	62	90	3016	197	1552

Sealing ring IG.054 CR for marine lower parts to be ordred seperately.

All dimensions in mm – If Stainless Steel grade AISI 316L / EN 1.4404 is required specify type no. with suffix S

# BLÜCHER® MarineLine proposals ...

## MESH GRATING CHANNEL

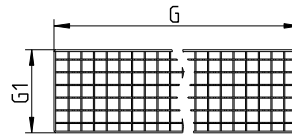
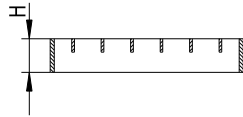

TYPE NO.	EAN NO.	NAME	G	G1	H	EN1253 (KG)	NON SLIP
696.223.144.49	5705499124415	150x500	499	144	25	R50 (3.500)	R12
696.223.144.99	5705499124439	150x1000	998	144	25	R50 (3.500)	R12
696.223.194.49	5705499124477	200x500	499	194	25	R50 (4.000)	R12
696.223.194.99	5705499124491	200x1000	998	194	25	R50 (4.000)	R12

## SHOWER GRATING CHANNEL

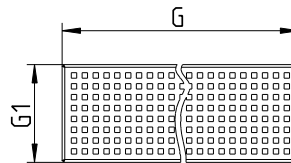
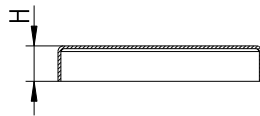

TYPE NO.	EAN NO.	NAME	G	G1	H	EN1253 (KG)	NON SLIP
697.015.150.50	5705499103182	150x500	499	144	25	K3 (500)	R10
697.015.150.99	5705499117394	150x1000	998	144	25	K3 (500)	R10
697.015.200.50	5705499117424	200x500	499	194	25	K3 (400)	R10
697.015.200.99	5705499124538	200x1000	998	194	25	K3 (400)	R10

## HYGIENICPRO GRATING CHANNEL

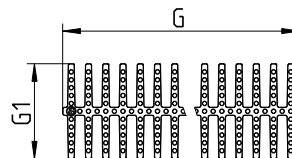
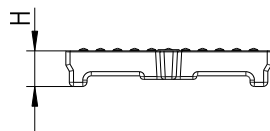

TYPE NO.	EAN NO.	NAME	G	G1	H	EN1253 (KG)	NON SLIP
697.250.150.50	5705499117868	150x500	499	145	25	M125 (10.000)	R10
697.250.200.50	5705499117967	200x500	499	195	25	M125 (10.000)	R10

All dimensions in mm – If Stainless Steel grade AISI 316L / EN 1.4404 is required specify type no. with suffix S

# BLÜCHER® MarineLine proposals ...

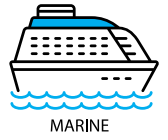

## TILED/EPOXY GRATING CHANNEL

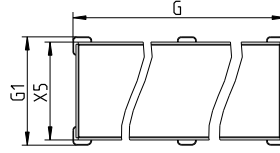
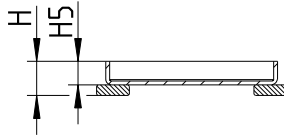

TYPE NO.	EAN NO.	NAME	G	G1	H	H5	X5	EN1253 (KG)
697.020.150.49	5705499128574	150x500	499	145	26	18	131	K3 (900)
697.020.200.49	5705499128581	200x500	499	195	26	18	181	L15 (1.800)

All dimensions in mm – If Stainless Steel grade AISI 316L / EN 1.4404 is required specify type no. with suffix S

# BLÜCHER® MarineLine proposals ...

**KITCHEN CHANNEL TYPE 660 FOR TILES AND EPOXY FLOORING**

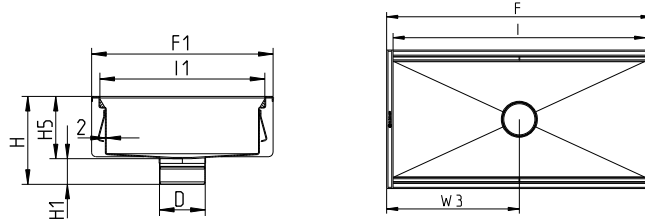

TYPE NO.	EAN NO.	NAME	D	F	F1	H	H1	H5	I	I1	W3
660FH004-06	5705499126174	400x400	110	437	437	121	61	60	397	397	218
660FH004-11	5705499126181	400x400	110	437	437	171	61	110	397	397	218
660FH008-06	5705499126204	400x800	110	837	437	121	61	60	797	397	418
660FH008-11	5705499126211	400x800	110	837	437	171	61	110	797	397	418
660GH005-06	5705499126303	500x500	110	537	537	121	61	60	497	497	268
660GH005-11	5705499126310	500x500	110	537	537	171	61	110	497	497	268
660GH010-06	5705499127874	500x1000	110	1037	537	121	61	60	997	497	518
660GH010-11	5705499127881	500x1000	110	1037	537	171	61	110	997	497	518

Sealing ring IG.054 CR for marine lower parts to be ordered separately.

**KITCHEN CHANNEL TYPE 662 FOR VINYL FLOORING**

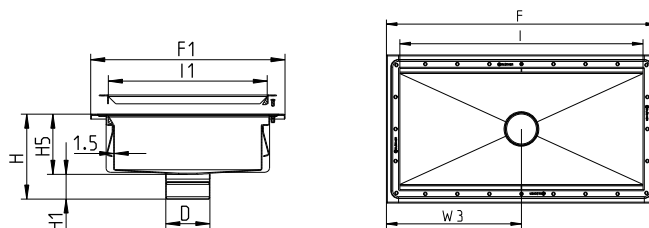

TYPE NO.	EAN NO.	NAME	D	F	F1	H	H1	H5	I	I1	W3	W3
662FH004-06	5705499126433	400x400	110	485	485	121	61	60	397	397	242	218
662FH008-06	5705499126457	400x800	110	885	485	121	61	60	797	397	442	418
662GH005-06	5705499126532	500x500	110	585	585	121	61	60	497	497	292	
662GH010-06	5705499126556	500x1000	110	1085	585	121	61	60	997	497	542	

Sealing ring IG.054 CR for marine lower parts to be ordered separately.

**MESH GRATING SQUARE**

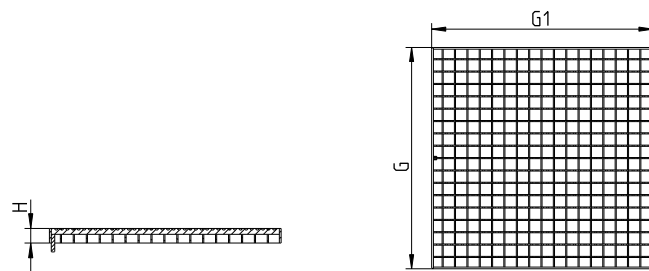
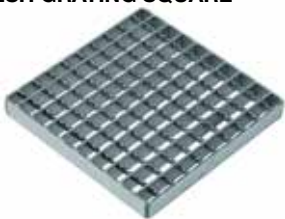

TYPE NO.	EAN no.	Name	G	G1	H	EN1253 (kg)	Non slip
696.223.394.395	5705499117356	400x400	394x394		25	L15 (1.500)	R12
696.223.494.495	5705499117363	500x500	494x494		25	L15 (1.500)	R12

All dimensions in mm – If Stainless Steel grade AISI 316L / EN 1.4404 is required specify type no. with suffix S



## BLÜCHER® MarineLine

**Material grade:** AISI 316L  
AISI 304

**Length:** \_\_\_\_\_ mm. (Can be customized as per request)

**Width:** 150, 200, 300, 400, 500, 600, 700, 800 mm

**Height:** \_\_\_\_\_ Minimum height possible is 40 mm (only in 2 mm thickness)

**Material thickness:** 2 mm material thickness

**Further details/possibilities:**

- Cross/Longitudinal fall for efficient self cleaning
- Channel in customized designs e.g. L, U and T shape is possible
- Can alternatively be supplied in 3-4 mm thickness for direct welding
- For further information please contact our Customer Center



Click for more info in the Marine Channel brochure



**Outlet size:** Ø110 mm

**Outlet position:** In center  
In end

 Sealing ring IG.054 CR

- Accessories:**
- Water trap (removable) 
  - OR**
  - P-water trap 
  - OR**
  - Filter basket 

**AND** filter plate 

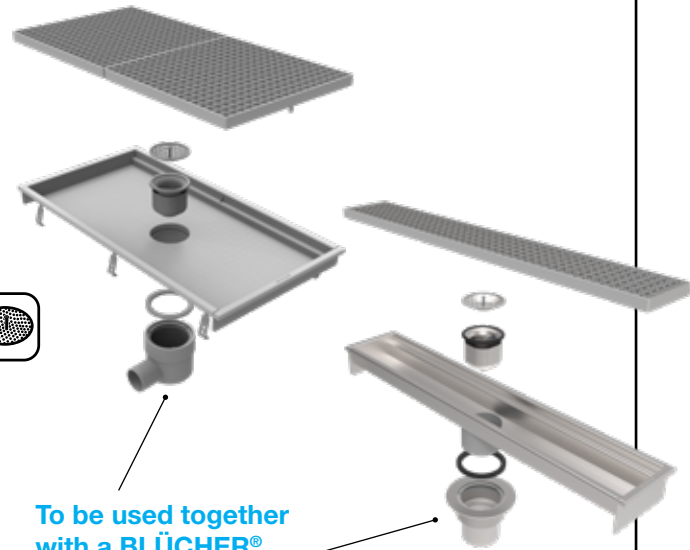

To be used together with a BLÜCHER® Marine lower part

**Grating Type:**

**Shower grating**



**Tiled/epoxy grating**



**Ladder grating**



**Ladder grating non-tilt**



**Mesh grating**

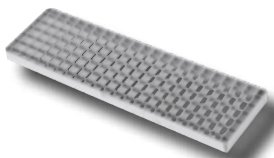

**Slot grating**



**Ladder grating - fully welded**



**HygenicPro® grating**

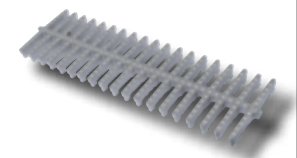



# BLÜCHER® MultiLine

- Scandinavian elegance



**NEW**

#### Applications

- Inside door openings, bathroom, shower areas, luxury suites, etc.

#### Highlights

- Low height
- With 2 mm frame width on all four sides
- Elegant design



**MultiLine request form**  
Find it here: [www.blucher-marine.com](http://www.blucher-marine.com)

## Details:

- Length: standard length of 800, 900, 1000 and 1200 mm
- Width: 132 mm outside
- Height: 19 mm for type Stockholm, and 28 mm for type Tokyo
- 2 mm material thickness
- Stainless steel AISI 304/ EN 1.4301
- Cross fall

## Gratings:

### STOCKHOLM GRATING



### TOKYO GRATING



## Outlet:





- Outlet pipe dimension is Ø110 mm
- Outlet placed in center

## Installation:

This channel is meant to be installed together with one of the different BLÜCHER Marine lower parts. The Marine lower part will be installed in the deck - either by welding or by a screw solution. We always recommend to use a MED approved Marine lower part.

## Options:



-  Water trap
-  Filter plate
-  Anchor tangs
-  Adjustable legs
-  P-trap

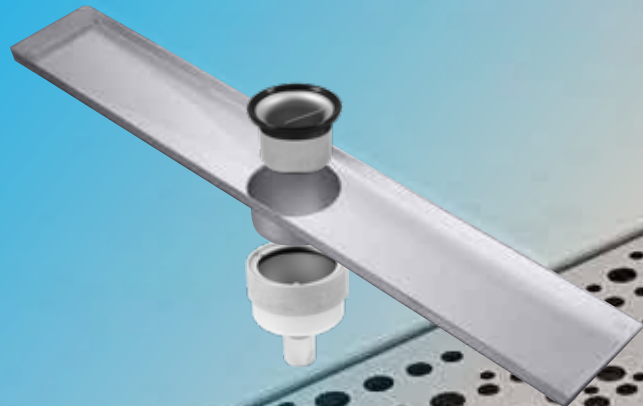

**BLÜCHER®**  
A WATTS Brand

# BLÜCHER® MultiLine proposals ...

## BLÜCHER MULTILINE INCL STOCKHOLM GRATING

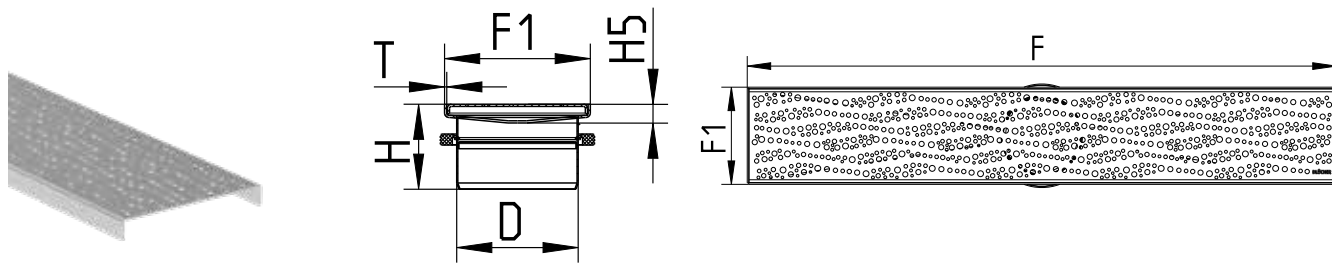

TYPE NO.	D	F	F1	H	H5	T	MATERIAL
651.300.080	Ø110	800	132	77	19	2	AISI 304
651.300.100	Ø110	1000	132	77	19	2	AISI 304
651.300.120	Ø110	1200	132	77	19	2	AISI 304

## BLÜCHER MULTILINE INCL TOKYO GRATING

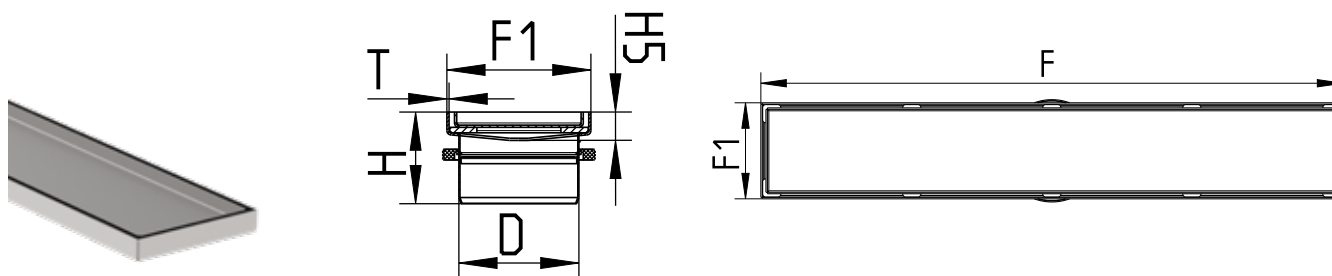

TYPE NO.	D	F	F1	H	H5	T	MATERIAL
651.350.080	Ø110	800	132	84	28	2	AISI 304
651.350.100	Ø110	1000	132	84	28	2	AISI 304
651.350.120	Ø110	1200	132	84	28	2	AISI 304

... you can also customize your own channel by using our MultiLine request form



MultiLine request form

Find it here: [www.blucher-marine.com](http://www.blucher-marine.com)





# BLÜCHER® MultiLine

- Material grade:** AISI 304
- Standard Length:** 800 mm      900 mm      1000 mm      1200 mm  
*(If a customized length is requested, please contact Customer Center)*
- Width:** 132 mm outside
- Height:** **19 mm** for type **Stockholm** grating and  
**28 mm** for type **Tokyo** grating
- Material thickness:** 2 mm material thickness
- Outlet size:** Ø110 mm
- Outlet position:** In center
- Further details/possibilities:** Cross fall

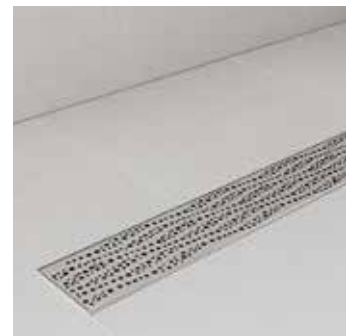
Click for more  
info in the  
Marine Channel  
brochure



**Accessories:** Water trap  
(removable) 

**AND** filter plate 

**OR**  
P-water trap 

**OR**  
Filter basket 

To be used together  
with a BLÜCHER®  
Marine lower part

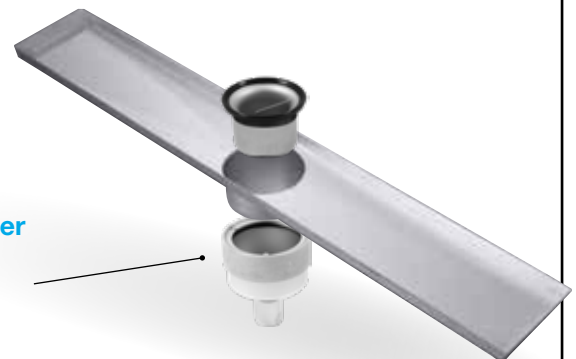

**Grating Type: STOCKHOLM Grating**



**TOKYO Grating**

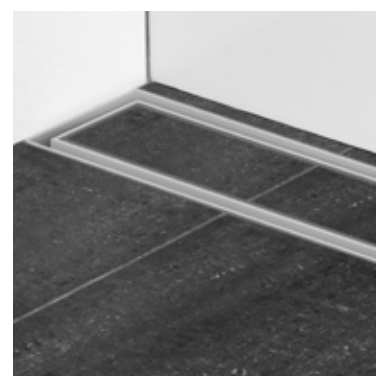

# Accessories

**ALL**  
**BLÜCHER® LOWER PARTS**  
**WILL FIT**  
**HERE IS A SELECTION**  
**- SEE ALL IN CHAPTER 3,**  
**BLÜCHER® DRAIN MARINE**

## Marine lower parts for steel decks

### LOWER PART FOR MARINE DRAIN TYPE 470.000 WITH WELDING SLEEVE

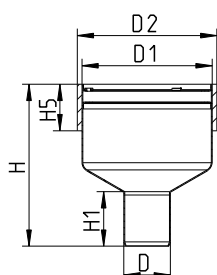

TYPE NO.	EAN NO.	EC/MED (DECK)	D	D1	H	H1	H5	D2	KG
470.000.050	5705499106138	A0-A60	50	140	174	58	50	150	1,73
470.000.050 S	5705499106145	A0-A60	50	140	174	58	50	150	1,73
470.000.075	5705499106152	A0-A60	75	140	172	63	50	150	1,60
470.000.075 S	5705499106169	A0-A60	75	140	172	63	50	150	1,60
470.000.110	5705499106176	A0-A60	110	140	146	75	50	150	1,70
470.000.110 S	5705499106183	A0-A60	110	140	146	75	50	150	1,70

### LOWER PART FOR MARINE DRAIN TYPE 470.200 WITH WELDING FLANGE

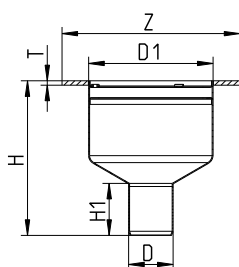

TYPE NO.	EAN NO.	EC/MED (DECK)	D	D1	Z	H	H1	T	KG
470.200.050	5705499106190	A0-A60	50	140	Ø200	174	58	5	1,30
470.200.050 S	5705499106206	A0-A60	50	140	Ø200	174	58	5	1,30
470.200.075	5705499106213	A0-A60	75	140	Ø200	172	63	5	1,40
470.200.075 S	5705499106220	A0-A60	75	140	Ø200	172	63	5	1,40
470.200.110	5705499106237	A0-A60	110	140	Ø200	141	75	5	1,24
470.200.110 S	5705499106244	A0-A60	110	140	Ø200	141	75	5	1,24

All dimensions in mm – If Stainless Steel grade AISI 316L /  
 EN 1.4404 is required specify type no. with suffix S





# Marine lower parts for steel decks

## LOWER PART FOR MARINE DRAIN TYPE 475.000 WITH WELDING SLEEVE

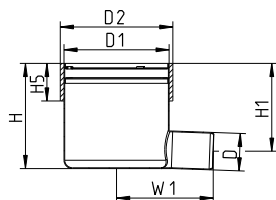

TYPE NO.	EAN NO.	EC/MED (DECK)	D	D1	H	H1	H5	W1	D2	KG
475.000.050	5705499106251	A0-A60	50	140	140	117	50	129	150	1,85
475.000.050 S	5705499106268	A0-A60	50	140	140	117	50	129	150	1,85
475.000.075	5705499106275	A0-A60	75	140	140	105	50	134	150	1,80
475.000.075 S	5705499106282	A0-A60	75	140	140	105	50	134	150	1,80

## LOWER PART FOR MARINE DRAIN, HIGH MODEL TYPE 475.100 WITH WELDING SLEEVE

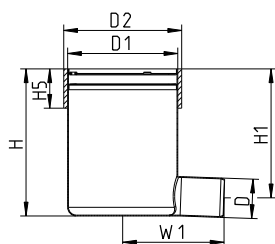

TYPE NO.	EAN NO.	EC/MED (DECK)	D	D1	H	H1	H5	W1	D2	KG
475.100.050	5705499106299	A0-A60	50	140	187	164	50	129	150	1,90
475.100.050 S	5705499106305	A0-A60	50	140	187	164	50	129	150	1,90

## LOWER PART FOR MARINE DRAIN TYPE 475.200 WITH WELDING FLANGE

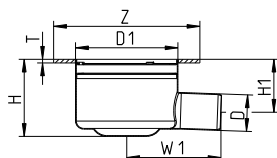

TYPE NO.	EAN NO.	EC/MED (DECK)	D	D1	Z	H	H1	W1	T	KG
475.200.050	5705499106312	A0-A60	50	140	Ø200	106	72	129	5	1,30
475.200.050 S	5705499106329	A0-A60	50	140	Ø200	106	72	129	5	1,30
475.200.075	5705499106336	A0-A60	75	140	Ø200	106	71	134	5	1,35
475.200.075 S	5705499106343	A0-A60	75	140	Ø200	106	71	134	5	1,35

All dimensions in mm – If Stainless Steel grade AISI 316L / EN 1.4404 is required specify type no. with suffix S

# Marine lower parts for steel decks

## REMOVABLE TWO-PART WATER TRAP TYPE 502.050 WITH EPDM SEALING RING

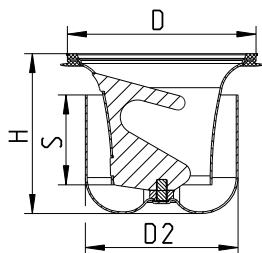

TYPE NO.	EAN NO.	D	H	S	D2	MAX FLOW (L/S)	KG	D2
502.050.110 M	5705499124064	108	89	50	85	1.7	0,36	150

Accurate flow rate depending on type of channel and grating.

## REMOVABLE MULTI WATER TRAP TYPE 503 WITH CR SEALING RING, PREVENTS SMELL AND BACK FLOW

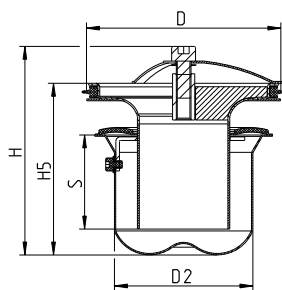

TYPE NO.	EAN NO.	D	H	H5	S	D2	MAX FLOW (L/S)	KG
503.000.110 CR	5705499131918	108	113	93	51	75	1.2	0,39

Accurate flow rate depending on type of drain and grating.

## P-TRAP 87.5° TYPE 525.090

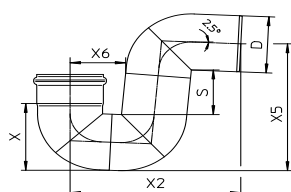

TYPE NO.	EAN NO.	D	S	X	X2	X5	X6	MIN FLOW (L/S)	MAX FLOW (L/S)
525.090.050 S	5705499101461	50	74	67	175	145	60	0.7	1.7
525.090.075 S	5705499101478	75	81	93	222	189	74	2.5	3.7
525.090.110 S	5705499101485	110	89	132	289	249	94	3.4	10.4

Accurate flow rate depending on type of channel and grating.

## ADJUSTABLE LEGS

TYPE NO.	EAN NO.	H
670.000.001	5705499116243	150
670.000.005	5705499131741	300

All dimensions in mm – If Stainless Steel grade AISI 316L / EN 1.4404 is required specify type no. with suffix S

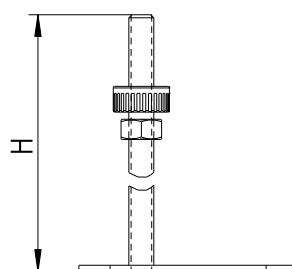



# Marine lower parts for steel decks

## REMOVABLE TWO-PART WATER TRAP TYPE 502.050

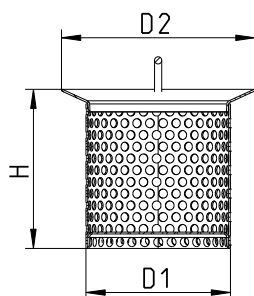

TYPE NO.	EAN NO.	D1	H	D2
780.107.110.05 S	5705499104486	80	88	107

## FILTER BASKET FOR TWO-PART WATER TRAP

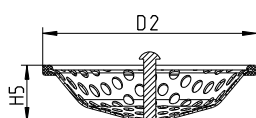

TYPE NO.	EAN NO.	H5	D2
502.000.000 S	5705499124101	24	106

FITS TRAP TYPE 502.050 AND TYPE 503.001

## GRATING CIRCLE VIENNA WITH SUPPORTING RING FOR WATER TRAP

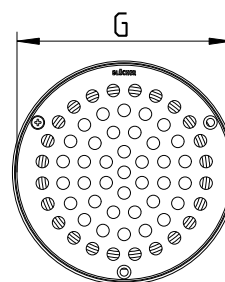
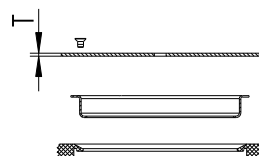

TYPE NO.	EAN NO.	G	T	SREWS	KG
474.300.110 S	5705499106428	Ø135	2	3	0,20

## EXTENSION PIPE TYPE 611

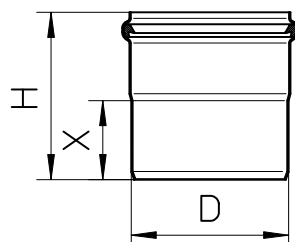

TYPE NO.	EAN NO.	D	H	X	KG
611.300.001 S	5705499106442	110	117	55	0,40

All dimensions in mm – If Stainless Steel grade AISI 316L / EN 1.4404 is required specify type no. with suffix S

# BLÜCHER® GREASE SEPARATOR

Waste water from food preparation contains greases and oils of animal or vegetable origin. Greases are poorly biodegradable, they generate toxic gases and pose a higher risk of pipeline corrosion. A study carried out by CNIDEP in 2007 states that in catering, restaurants and food-processing companies, the grease comes from mainly 3 processes: 54% from cooking, 30% from manual dish-washing and 7% originates from machine dish-washing.

A grease separator separates and retains the separated grease and fat residues within the unit before the wastewater enters the wastewater pipe system. This means that the buildup of grease deposits that would otherwise disturb the proper operation of the wastewater pipe system will be minimized, thus lowering maintenance costs significantly.

### Efficient Grease Control

The BLÜCHER® Grease Separators are a modern evolution of the traditional grease/fat trap. The BLÜCHER® Grease Separators act as a point of treatment for a liquid digestion media (LDM). The digestion media can be introduced either manually or automatically.

### How it works

The illustration below shows how the Grease Separators work. The wastewater enters into the first chamber and meets the first wall. This wall forces the flow down to the bottom of the separator and ensures that the surface is more stagnant so that grease rises to the surface due to the lower weight compared to water, and remains in the tank. The second wall holds the grease and presses the wastewater underneath and out of the outlet pipe.

When the digestion media is added to the grease separator (either automatically with a dosing unit or manually), the enzymes start to "eat" the fat, thus ensuring longer intervals between emptying the Grease Separator of grease and fat.

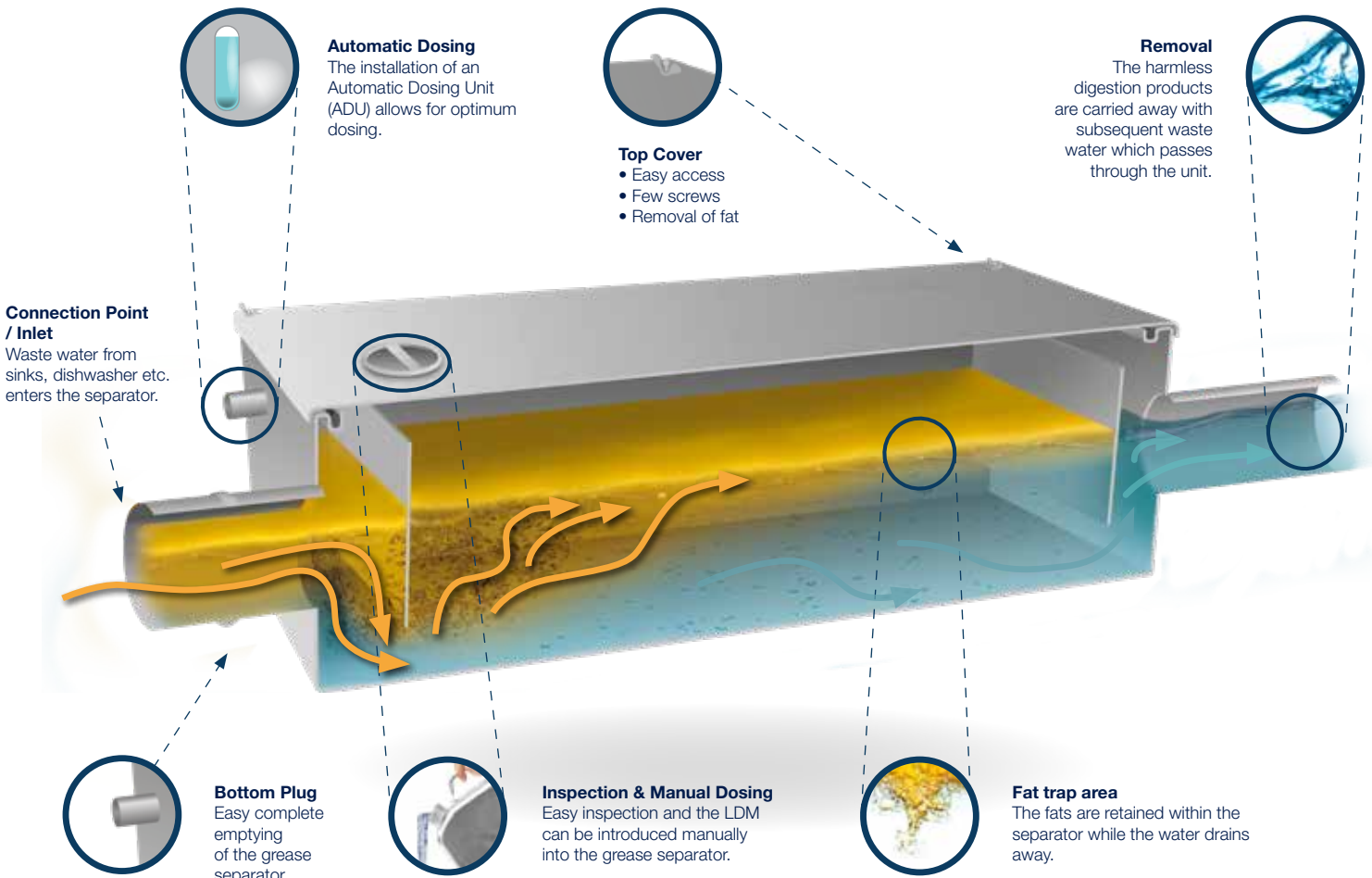

## BLÜCHER® GREASE SEPARATOR TYPE NOS. AND SIZES

In catering, restaurants, food-processing etc. the proper function of the grease separator depends mainly on the amount of fat residue and very little on the flow volume, therefore sizing according to EN 1825-2 standard, where using the number of meals served per day, will provide the most accurate sizing.

The formula used is the following:

**NS = Number of meals x V meals x fd x ft x fr x fq (3600 x daily operating time)**

fd: density factor; ft: temperature factor; fr: cleansing agent factor; fq: peak factor

The above formula has been used to determine the size/ dimensioning of the BLÜCHER® Grease Separators.

The BLÜCHER® Grease Separator comes in 4 sizes with capacity ranging from 35 to 210 meals per day. See the product range below.

### Type number: 970-14155-01

Stainless steel Grease Separator Grade AISI 304  
Size LxWxD: 684mm x 578mm x 289mm  
Inlet and outlet: OD 110mm

#### Meals per day: 35

Recommended dosing media ml/day: 100\*

### Type number: 970-14155-03

Stainless steel Grease Separator Grade AISI 304  
Size LxWxD: 756mm x 506mm x 502mm  
Inlet and outlet: OD 110mm

#### Meals per day: 85

Recommended dosing media ml/day: 100\*



### Type number: 970-14155-07

Stainless steel Grease Separator Grade AISI 304  
Size LxWxD: 1006mm x 506mm x 702mm  
Inlet and outlet: OD 110mm

#### Meals per day: 210

Recommended dosing media ml/day: 200\*

### Type number: 970-14155-05

Stainless steel Grease Separator Grade AISI 304  
Size LxWxD: 756mm x 506mm x 702mm  
Inlet and outlet: OD 110mm

#### Meals per day: 160

Recommended dosing media ml/day: 150\*

## BLÜCHER® DOZING UNIT - COMPACT

The dosing unit is a programmable dosing system for grease separators, and housed in a wall mounted, stainless steel cabinet. The system comes with a 12.5 liter bottle of Bacti-G biological media and programmed for standard dose.

The Bacti-G is fully encased to minimize risk of accidental spillage.

Battery, mains operated and mains with BMS versions available to suit all situations. BMS version alerts power failure and liquid depletion.

The doser comes pre-programmed with all the necessary fittings required for installation.

### Type number: MODD1/CABINET

Stainless steel dosing unit and housing

The unit comes complete with pre-programmed mains operated peristaltic pump + 5 litres of dosing medium in a 12.5 litre bottle and all connecting tubes with 2 metres of cable to connect to the mains electricity supply (230 V)



MODD1/CABINET

MODD1

### Type number: MODD1

Only dosing unit without housing and Liquid Digestion Media

#### Liquid Digestion Media

Liquid type no. 691160 (12 litres bottle – for automatic dosing)  
Powder type no. 691180 (18 kg comes in a pack of 24 numbers)



# STAINLESS STEEL – MARINE APPLICATIONS

## Installation videos

As a supplement to the printed installation instructions for the BLÜCHER® products used in marine applications, the following installation videos are available at [www.blucher-marine.com](http://www.blucher-marine.com) (select the tab "Installation videos"):

### BLÜCHER® EuroPipe

Cutting of pipes with electrical pipe cutter



### BLÜCHER® Drain Marine

Installation in decks



### BLÜCHER® EuroPipe

Cutting of pipes with manual pipe cutter



### BLÜCHER® Drain Marine

Water trap



### BLÜCHER® EuroPipe

Introduction to use and applications



### BLÜCHER®

Non-welded penetrations



## Other videos

Available at [www.blucher-marine.com](http://www.blucher-marine.com)

### BLÜCHER® Marine

Passenger safety



### BLÜCHER® Marine

Company presentation



### BLÜCHER® Marine

Combustible sanitary piping systems



### BLÜCHER® WaterLine

Shower channels



### Safety at Sea

See all the work we do within fire testing



### NEW Plug & Play Penetration

Installed without welding in less than 60 sec.







**Your drainage partner  
keeps up your flow**

**BLÜCHER® EuroPipe**

**BLÜCHER® Channel**

**BLÜCHER® Drain**



**BLÜCHER® EuroPipe**  
Stainless steel drainage pipework system

**BLÜCHER®**

A **WATTS** Brand

T: +45 99 92 08 00 • [BLUCHER.com](https://www.blucher.com)

© 2024 BLUCHER.com